



MIC28304

70V 3A Power Module

Hyper Speed Control™ Family



General Description

Micrel's MIC28304 is synchronous step-down regulator module, featuring a unique adaptive ON-time control architecture. The module incorporates a DC/DC controller, power MOSFETs, bootstrap diode, bootstrap capacitor and an inductor in a single package. The MIC28304 operates over an input supply range from 4.5V to 70V and can be used to supply up to 3A of output current. The output voltage is adjustable down to 0.8V with a guaranteed accuracy of $\pm 1\%$. The device operates with programmable switching frequency from 200kHz to 600kHz.

Micrel's HyperLight Load® architecture provides the same high-efficiency and ultra-fast transient response as the Hyper Speed Control™ architecture under the medium to heavy loads, but also maintains high efficiency under light load conditions by transitioning to variable frequency, discontinuous-mode operation.

The MIC28304 offers a full suite of protection features. These include undervoltage lockout, internal soft-start, foldback current limit, "hiccup" mode short-circuit protection, and thermal shutdown.

Datasheets and support documentation are available on Micrel's web site at: www.micrel.com.

Hyper Speed Control™

Features

- Easy to use
 - Stable with low-ESR ceramic output capacitor
 - No compensation and no inductor to choose
- 4.5V to 70V input voltage
- Single-supply operation
- Power Good (PG) output
- Low radiated emission (EMI) per EN55022, Class B
- Adjustable current limit
- Adjustable output voltage from 0.9V to 24V (also limited by duty cycle)
- 200kHz to 600kHz, programmable switching frequency
- Supports safe start-up into a pre-biased output
- -40°C to $+125^{\circ}\text{C}$ junction temperature range
- Available in 64-pin, 12mm x 12mm x 3mm QFN package

Applications

- Distributed power systems
- Industrial, medical, telecom, and automotive

Typical Application

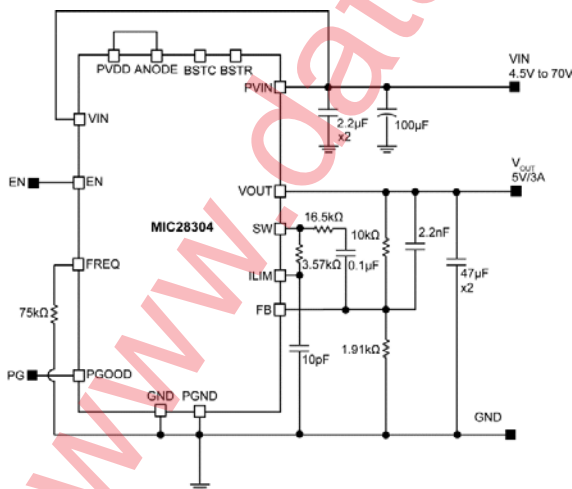

Efficiency vs. Output Current (MIC28304-1)

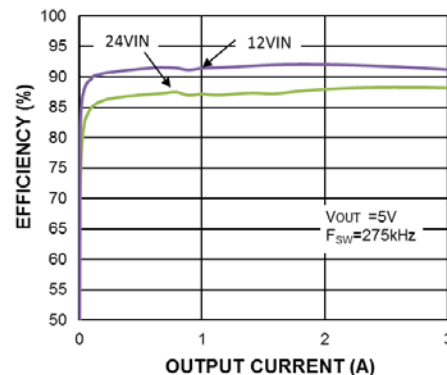

Hyper Speed Control and Any Capacitor are trademarks of Micrel, Inc.

HyperLight Load is a registered trademark of Micrel, Inc.

Micrel Inc. • 2180 Fortune Drive • San Jose, CA 95131 • USA • tel +1 (408) 944-0800 • fax + 1 (408) 474-1000 • <http://www.micrel.com>

Ordering Information

Part Number	Switching Frequency	Features	Package	Junction Temperature Range	Lead Finish
MIC28304-1YMP	200kHz to 600kHz	HyperLight Load	64-pin 12mm x 12mm QFN	-40°C to +125°C	Pb-Free
MIC28304-2YMP	200kHz to 600kHz	Hyper Speed Control	64-pin 12mm x 12mm QFN	-40°C to +125°C	Pb-Free

Pin Configuration

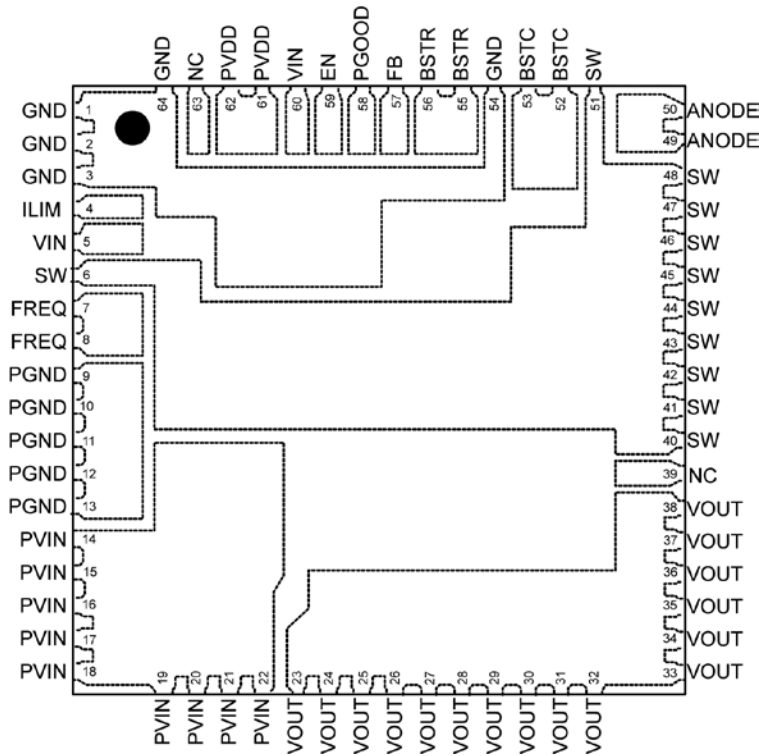

**64-Pin 12mm x 12mm QFN (MP)
(Top View)**

Pin Description

Pin Number	Pin Name	Pin Function
1, 2, 3, 54, 64	GND	Analog Ground. Ground for internal controller and feedback resistor network. The analog ground return path should be separate from the power ground (PGND) return path.
4	ILIM	Current Limit Setting. Connect a resistor from SW (pin #4) to ILIM to set the over-current threshold for the converter.
5, 60	VIN	Supply Voltage for Controller. The VIN operating voltage range is from 4.5V to 70V. A 0.47µF ceramic capacitor from VIN (pin # 60) to AGND is required for decoupling. The pin # 5 should be externally connected to either PVIN or pin # 60 on PCB.
6, 40 to 48, 51	SW	Switch Node and Current-Sense Input. High current output driver return. The SW pin connects directly to the switch node. Due to the high-speed switching on this pin, the SW pin should be routed away from sensitive nodes. The SW pin also senses the current by monitoring the voltage across the low-side MOSFET during OFF time.

Pin Description (Continued)

Pin Number	Pin Name	Pin Function
7, 8	FREQ	Switching Frequency Adjust Input. Leaving this pin open will set the switching frequency to 600kHz. Alternatively a resistor from this pin to ground can be used to lower the switching frequency.
9 to 13	PGND	Power Ground. PGND is the return path for the buck converter power stage. The PGND pin connects to the sources of low-side N-Channel external MOSFET, the negative terminals of input capacitors, and the negative terminals of output capacitors. The return path for the power ground should be as small as possible and separate from the analog ground (GND) return path.
14 to 22	PVIN	Power Input Voltage. Connection to the drain of the internal high-side power MOSFET.
23 to 38	VOUT	Output Voltage. Connection with the internal inductor, the output capacitor should be connected from this pin to PGND as close to the module as possible.
39	NC	No Connection. Leave it floating.
49, 50	ANODE	Anode Bootstrap Diode Input. Anode connection of internal bootstrap diode, this pin should be connected to the PVDD pin.
52, 53	BSTC	Bootstrap Capacitor. Connection to the internal bootstrap capacitor. Leave floating, no connect.
55, 56	BSTR	Bootstrap Resistor. Connection to the internal bootstrap resistor and high-side power MOSFET drive circuitry. Leave floating, no connect.
57	FB	Feedback Input. Input to the transconductance amplifier of the control loop. The FB pin is regulated to 0.8V. A resistor divider connecting the feedback to the output is used to set the desired output voltage.
58	PGOOD	Power Good Output. Open drain output, an external pull-up resistor to external power rails is required.
59	EN	Enable Input. A logic signal to enable or disable the buck converter operation. The EN pin is CMOS compatible. Logic high enables the device, logic low shutdowns the regulator. In the disable mode, the input supply current for the device is minimized to 4 μ A typically. Do not pull EN to PVDD.
61, 62	PVDD	Internal +5V Linear Regulator Output. PVDD is the internal supply bus for the device. In the applications with VIN < +5.5V, PVDD should be tied to VIN to by-pass the linear regulator.
63	NC	No Connection. Leave it floating.

Absolute Maximum Ratings⁽¹⁾

PVIN, VIN to PGND	-0.3V to +76V
PVDD, V _{ANODE} to PGND	-0.3V to +6V
V _{SW} , V _{FREQ} , V _{ILIM} , V _{EN}	-0.3V to (PVIN +0.3V)
V _{BSTC/BSTR} to V _{SW}	-0.3V to 6V
V _{BSTC/BSTR} to PGND.....	-0.3V to 82V
V _{FB} , V _{PG} to PGND	-0.3V to (PVDD + 0.3V)
PGND to AGND.....	-0.3V to +0.3V
Junction Temperature	+150°C
Storage Temperature (T _S).....	-65°C to +150°C
Lead Temperature (soldering, 10s).....	260°C
ESD Rating ⁽³⁾	ESD Sensitive

Operating Ratings⁽²⁾

Supply Voltage (PVIN, VIN)	4.5V to 70V
Enable Input (V _{EN})	0V to VIN
V _{SW} , V _{FREQ} , V _{ILIM} , V _{EN}	0V to VIN
Power Good (V _{PGOOD}).....	0V to PVDD
Junction Temperature (T _J)	-40°C to +125°C
Junction Thermal Resistance	
12mm x 12mm QFN-64 (θ _{JA})	20°C/W
12mm x 12mm QFN-64 (θ _{JC}).....	5°C/W

Electrical Characteristics⁽⁴⁾

PVIN = VIN = 12V, V_{OUT} = 5V, V_{BST} - V_{SW} = 5V; T_A = 25°C, unless noted. **Bold** values indicate -40°C ≤ T_J ≤ +125°C.

Parameter	Condition	Min.	Typ.	Max.	Units
Power Supply Input					
Input Voltage Range (PVIN, VIN)		4.5		70	V
Controller Supply Current ⁽⁵⁾	Current into Pin 60; VFB = 1.5V (MIC28304-1)		0.4	0.75	mA
	Current into Pin 60; VFB = 1.5V (MIC28304-2)		2.1	3	
	Current into Pin 60; V _{EN} = 0V		0.1	10	μA
Operating Current	I _{OUT} = 0A (MIC28304-1)		0.7		mA
	I _{OUT} = 0A (MIC28304-2)		27		
Shutdown Supply Current	PVIN = VIN = 12V, V _{EN} = 0V		4		μA
PVDD Supply⁽⁵⁾					
PVDD Output Voltage	VIN = 7V to 70V, I _{PVDD} = 10mA	4.8	5.2	5.4	V
PVDD UVLO Threshold	PVDD rising	3.8	4.2	4.7	V
PVDD UVLO Hysteresis			400		mV
Load Regulation	I _{PVDD} = 0 to 40mA	0.6	2	3.6	%
Reference⁽⁵⁾					
Feedback Reference Voltage	T _J = 25°C (±1.0%)	0.792	0.8	0.808	V
	-40°C ≤ T _J ≤ 125°C (±2%)	0.784	0.8	0.816	
FB Bias Current	V _{FB} = 0.8V		5	500	nA

Notes:

- Exceeding the absolute maximum ratings may damage the device.
- The device is not guaranteed to function outside its operating ratings.
- Devices are ESD sensitive. Handling precautions are recommended. Human body model, 1.5kΩ in series with 100pF.
- Specification for packaged product only.
- IC tested prior to assembly.

Electrical Characteristics⁽⁴⁾ (Continued)

PVIN = VIN = 12V, V_{OUT} = 5V, V_{BST} - V_{SW} = 5V; T_A = 25°C, unless noted. **Bold** values indicate -40°C ≤ T_J ≤ +125°C.

Parameter	Condition	Min.	Typ.	Max.	Units
Enable Control					
EN Logic Level High		1.8			V
EN Logic Level Low				0.6	V
EN Hysteresis			200		mV
EN Bias Current	V _{EN} = 12V		5	20	μA
Oscillator					
Switching Frequency	FREQ pin = open	400	600	750	kHz
	RFREQ = 100kΩ (FREQ pin-to-GND)		300		
Maximum Duty Cycle			85		%
Minimum Duty Cycle	V _{FB} > 0.8V		0		%
Minimum Off-Time		140	200	260	ns
Soft-Start⁽⁵⁾					
Soft-Start Time			5		ms
Short-Circuit Protection⁽⁵⁾					
Current-Limit Threshold (V _{CL})	V _{FB} = 0.79V	-30	-14	0	mV
Short-Circuit Threshold	V _{FB} = 0V	-23	-7	9	mV
Current-Limit Source Current	V _{FB} = 0.79V	60	80	100	μA
Short-Circuit Source Current	V _{FB} = 0V	27	36	47	μA
Leakage					
SW, BSTR Leakage Current				50	μA
Power Good⁽⁵⁾					
Power Good Threshold Voltage	Sweep V _{FB} from low-to-high	85	90	95	%V _{OUT}
Power Good Hysteresis	Sweep V _{FB} from high-to-low		6		%V _{OUT}
Power Good Delay Time	Sweep V _{FB} from low-to-high		100		μs
Power Good Low Voltage	V _{FB} < 90% × V _{NOM} , I _{PG} = 1mA		70	200	mV
Thermal Protection					
Overtemperature Shutdown	T _J Rising		160		°C
Overtemperature Shutdown Hysteresis			4		°C

Electrical Characteristics⁽⁴⁾ (Continued)

PVIN = VIN = 12V, V_{OUT} = 5V, V_{BST} - V_{SW} = 5V; T_A = 25°C, unless noted. **Bold** values indicate -40°C ≤ T_J ≤ +125°C.

Parameter	Condition	Min.	Typ.	Max.	Units
Output Characteristic					
Output Voltage Ripple	I _{OUT} = 3A		16		mV
Line Regulation	PVIN = VIN = 7V to 70V, I _{OUT} = 3A		0.36		%
Load Regulation	I _{OUT} = 0A to 3A PVIN= VIN =12V (MIC28304-1)		0.75		%
	I _{OUT} = 0A to 3A PVIN= VIN =12V (MIC28304-2)		0.05		
Output Voltage Deviation from Load Step	I _{OUT} from 0A to 3A at 5A/μs (MIC28304-1)		400		mV
	I _{OUT} from 3A to 0A at 5A/μs (MIC28304-1)		500		
	I _{OUT} from 0A to 3A at 5A/μs (MIC28304-2)		400		
	I _{OUT} from 3A to 0A at 5A/μs (MIC28304-2)		500		

Typical Characteristics – 275kHz Switching Frequency

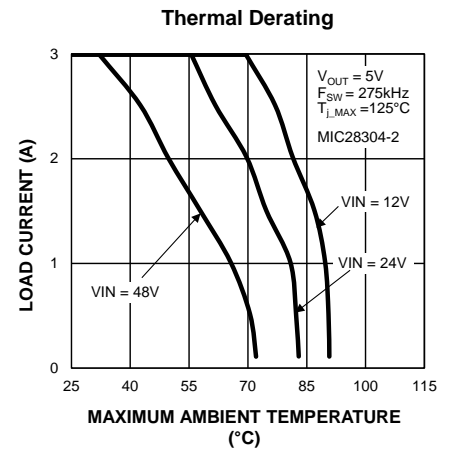
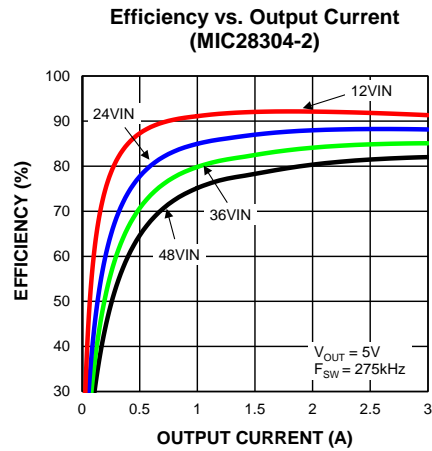
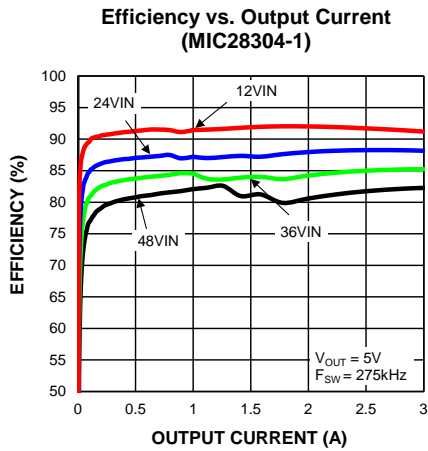
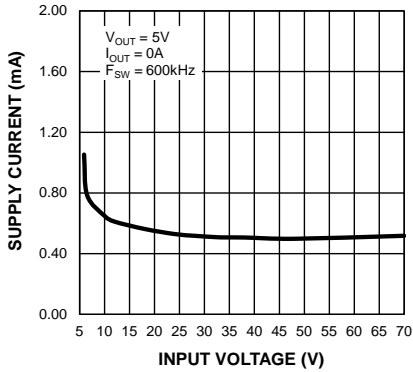

Table 1. Recommended Component Values for 275kHz Switching Frequency

V _{OUT}	V _{IN}	R3 (R _{in})	R19	R15	R1 (Top Feedback Resistor)	R11 (Bottom Feedback Resistor)	C10 (C _{inj})	C12 (C _{ff})	C _{OUT}
5V	7V to 18V	16.5kΩ	75kΩ	3.57k	10kΩ	1.9kΩ	0.1μF	2.2nF	2x47μF/6.3V
5V	18V to 70V	39.2kΩ	75kΩ	3.57k	10kΩ	1.9kΩ	0.1μF	2.2nF	2x 47μF/6.3V
3.3V	5V to 18V	16.5kΩ	75kΩ	3.57k	10kΩ	3.24kΩ	0.1μF	2.2nF	2x 47μF/6.3V
3.3V	18V to 70V	39.2kΩ	75kΩ	3.57k	10kΩ	3.24kΩ	0.1μF	2.2nF	2x 47μF/6.3V

Typical Characteristics

VIN Operating Supply Current vs. Input Voltage (MIC28304-1)



Output Regulation vs. Input Voltage (MIC28304-1)

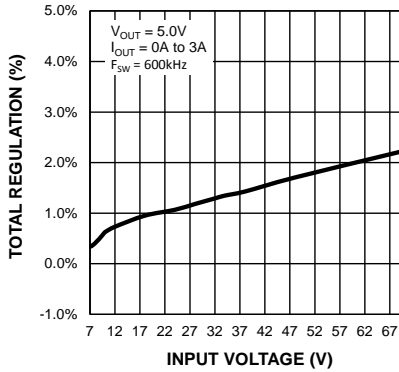

Feedback Voltage vs. Input Voltage (MIC28304-1)

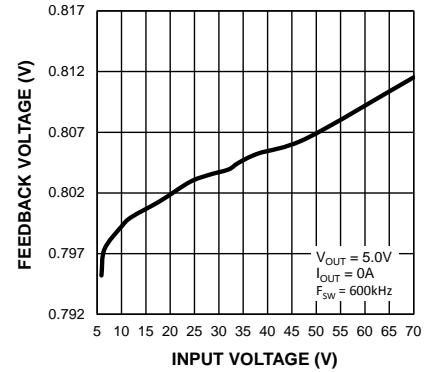

Output Voltage vs. Input Voltage (MIC28304-1)

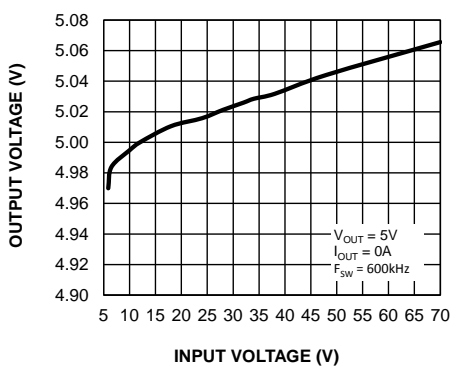

VIN Operating Supply Current vs. Temperature (MIC28304-1)

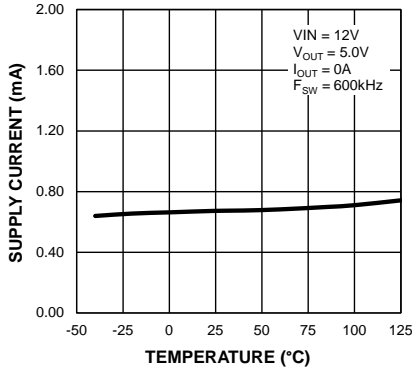

Feedback Voltage vs. Temperature (MIC28304-1)

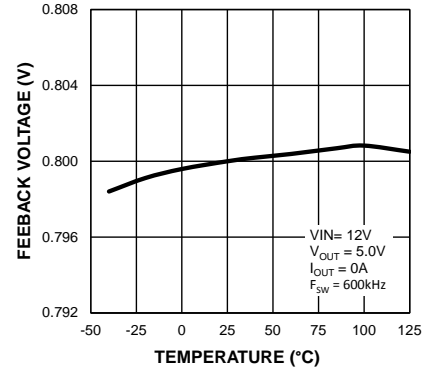

Load Regulation vs. Temperature (MIC28304-1)

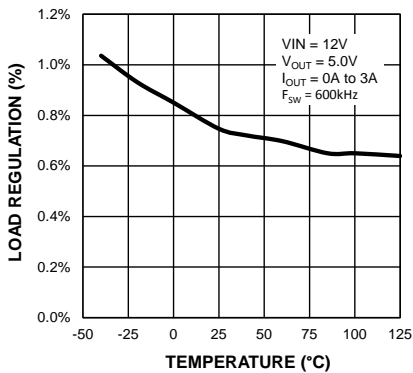

Line Regulation vs. Temperature (MIC28304-1)

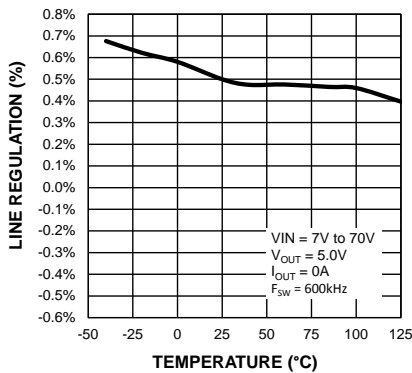

Line Regulation vs. Temperature (MIC28304-1)

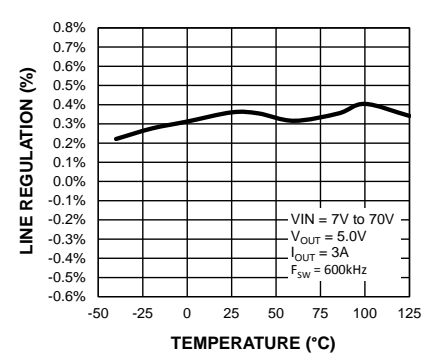

Typical Characteristics (Continued)

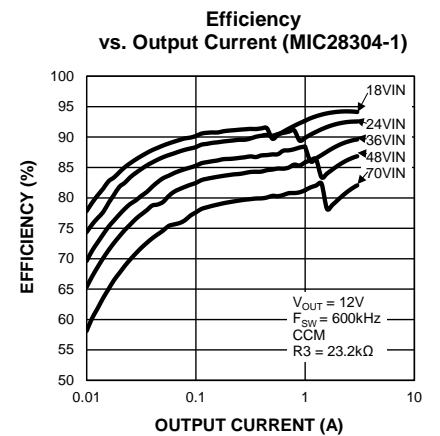
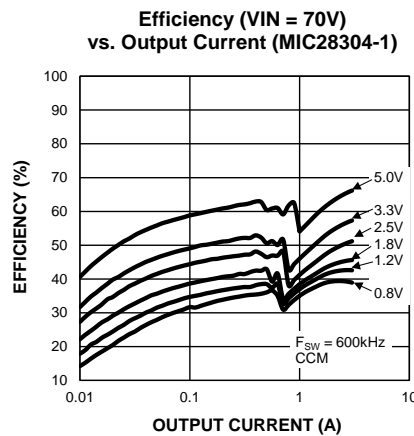
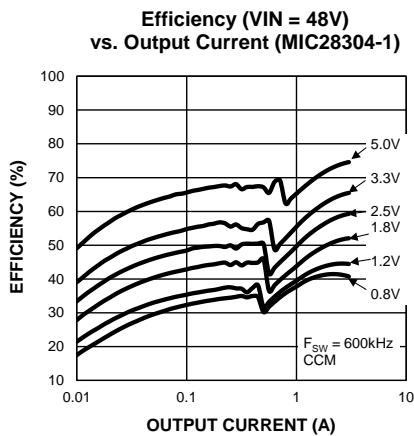
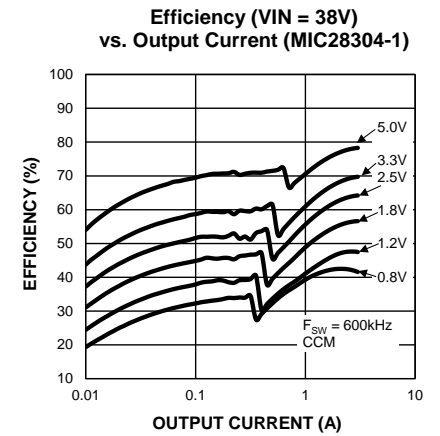
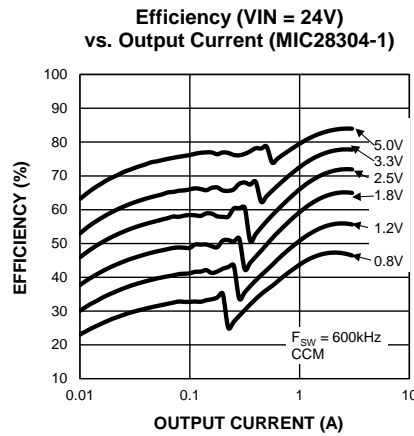
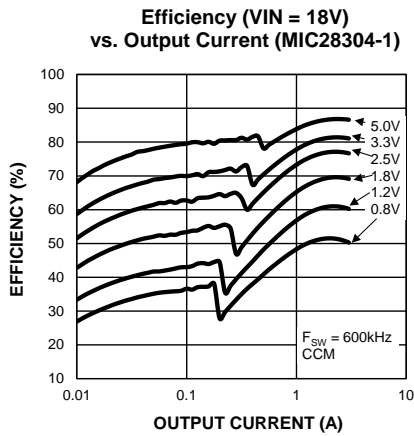
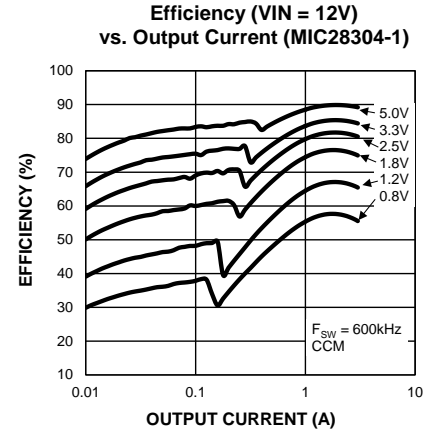
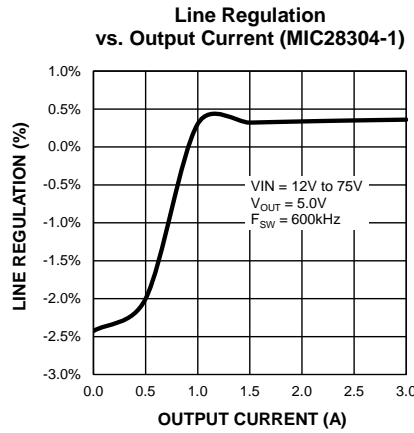
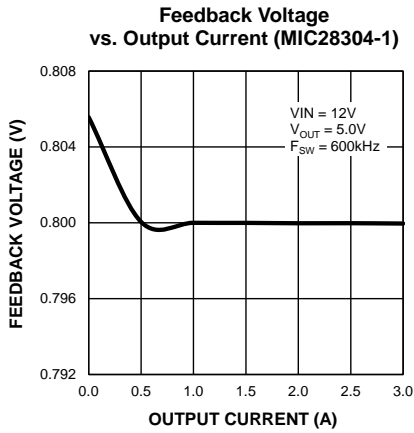

Typical Characteristics (Continued)

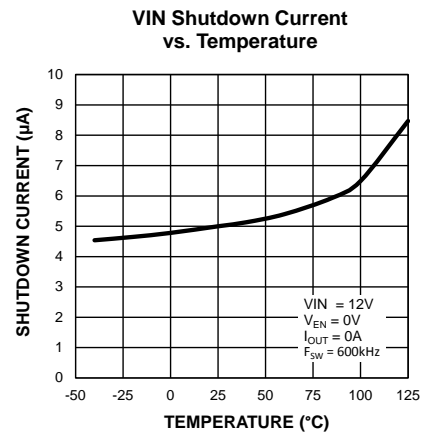
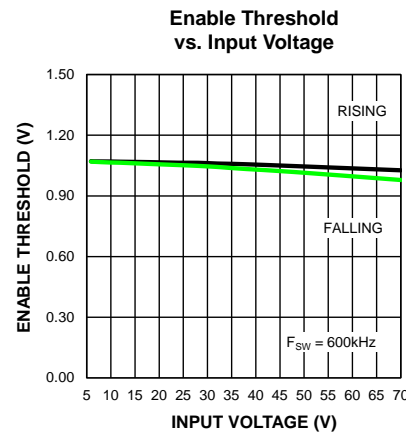
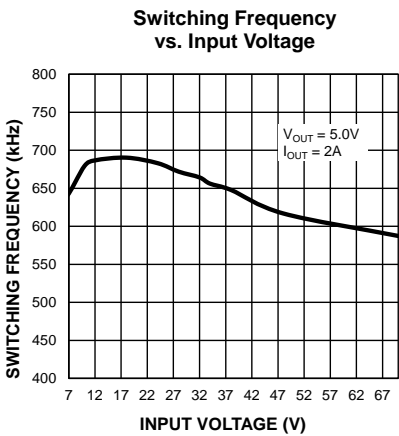
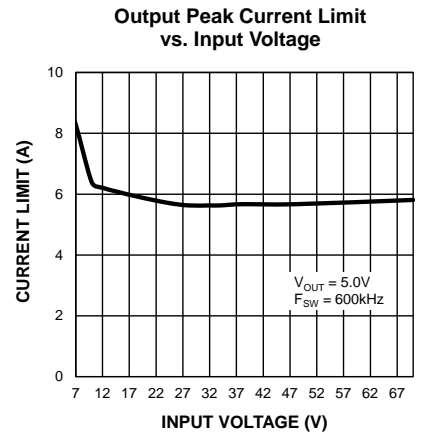
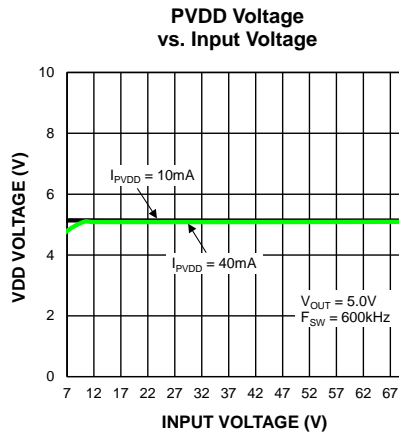
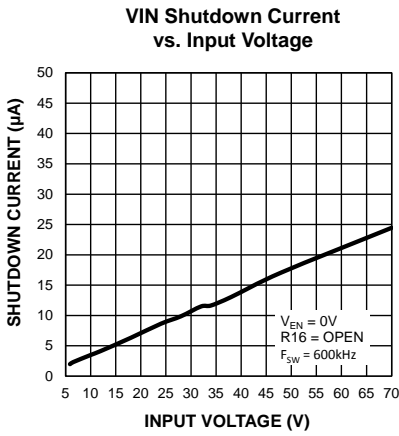
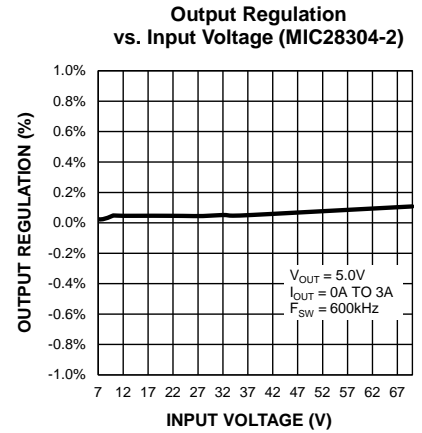
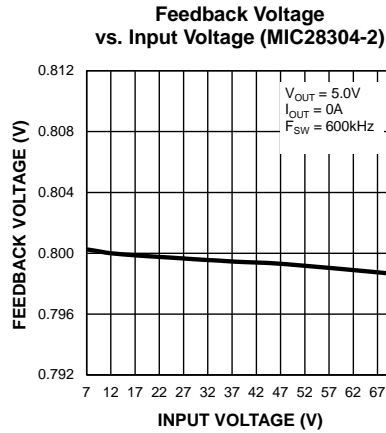
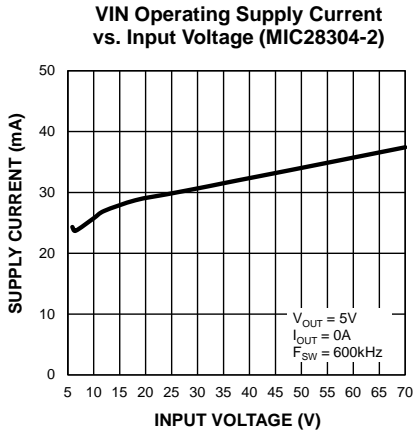

Typical Characteristics (Continued)

PVDD Voltage vs. Temperature

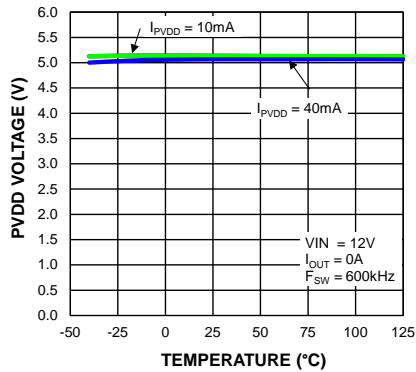

PVDD UVLO Threshold vs. Temperature

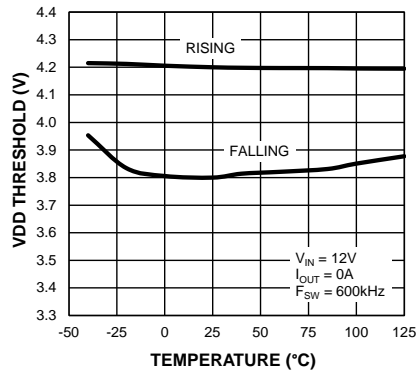

Output Peak Current Limit vs. Temperature

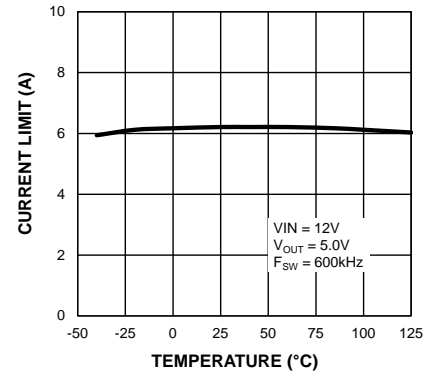

EN Bias Current vs. Temperature

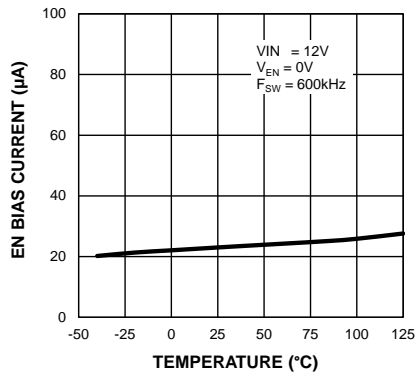

Enable Threshold vs. Temperature

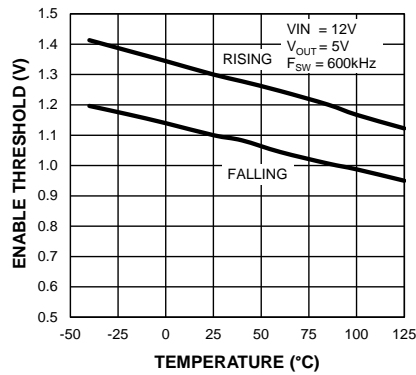

VIN Operating Supply Current vs. Temperature (MIC28304-2)

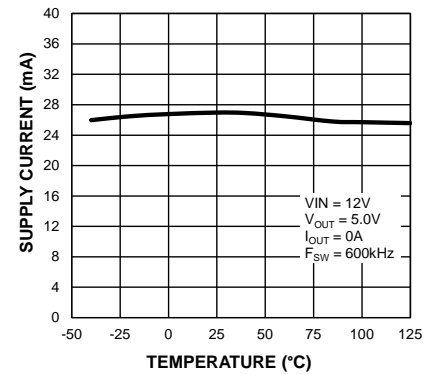

Feedback Voltage vs. Temperature (MIC28304-2)

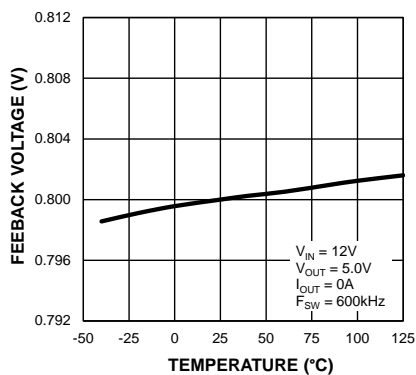

Load Regulation vs. Temperature (MIC28304-2)

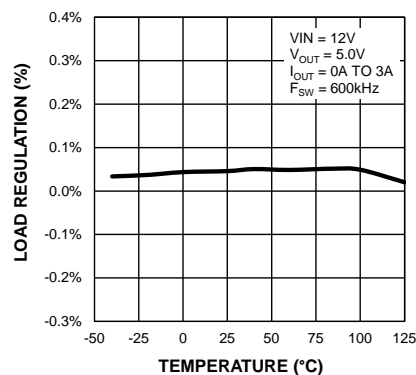

Line Regulation vs. Temperature (MIC28304-2)

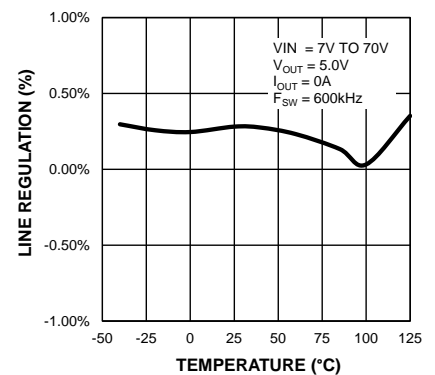

Typical Characteristics (Continued)

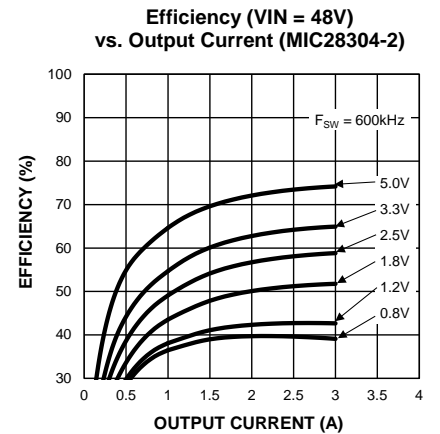
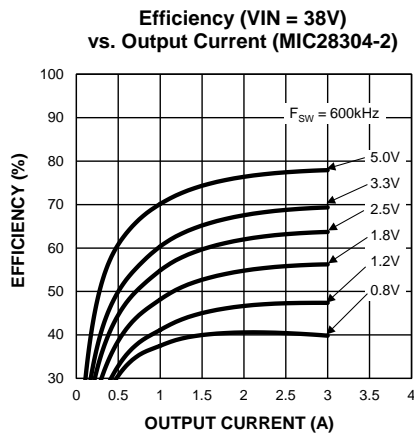
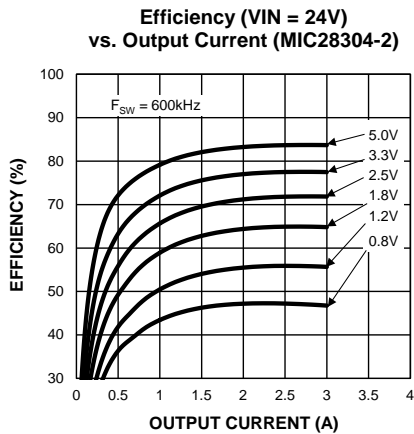
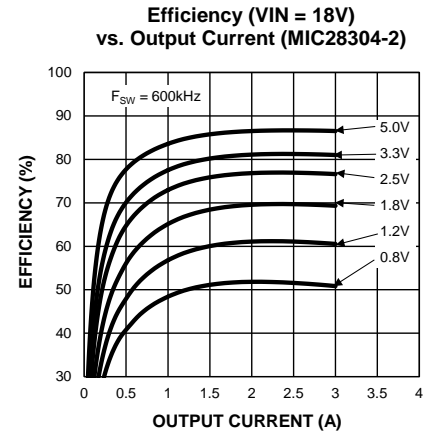
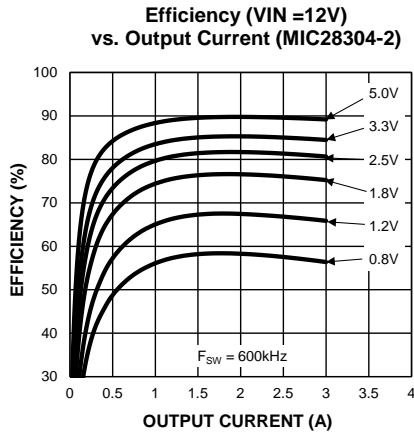
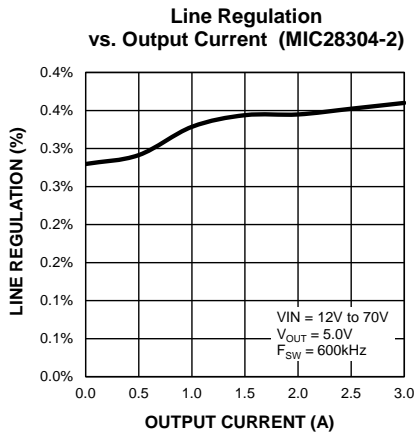
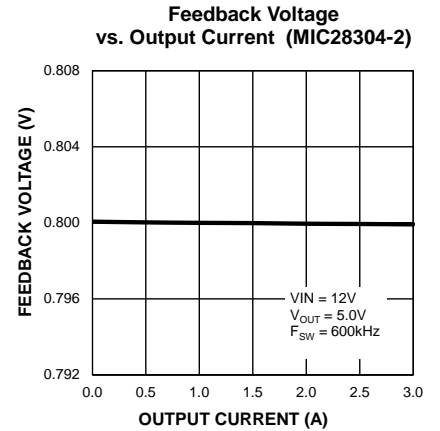
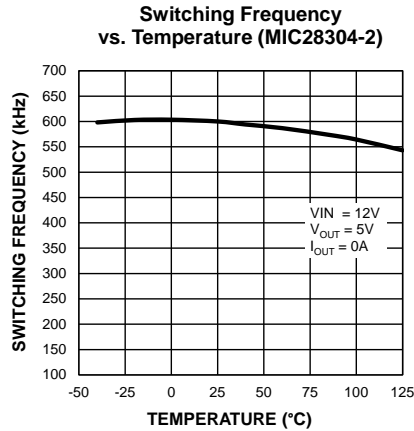
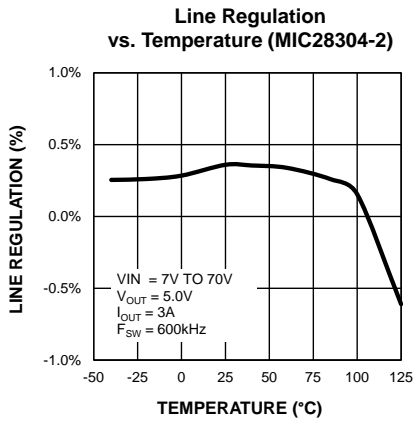

Typical Characteristics (Continued)

**Efficiency (VIN = 70V)
vs. Output Current (MIC28304-2)**

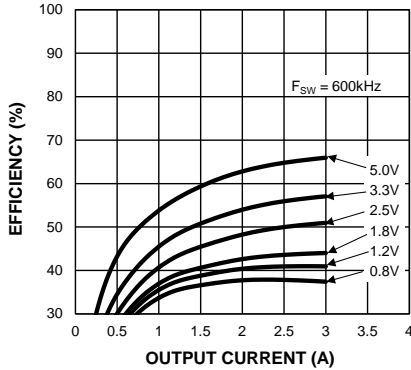

**Die Temperature* (VIN = 12V)
vs. Output Current (MIC28304-2)**

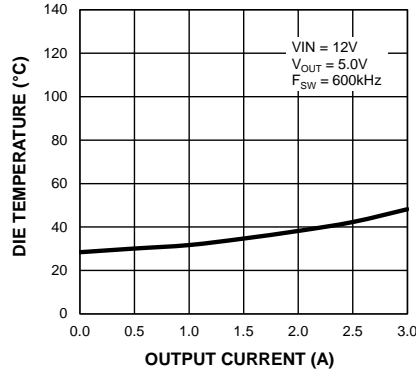

**Die Temperature* (VIN = 48V)
vs. Output Current (MIC28304-2)**

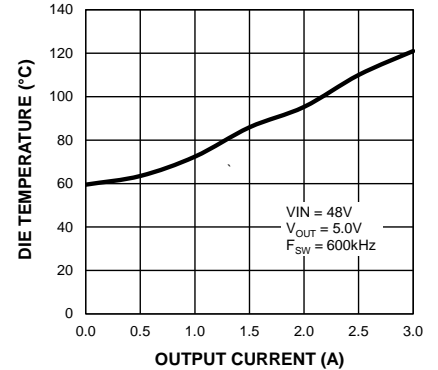

**Die Temperature* (VIN = 70V)
vs. Output Current (MIC28304-2)**

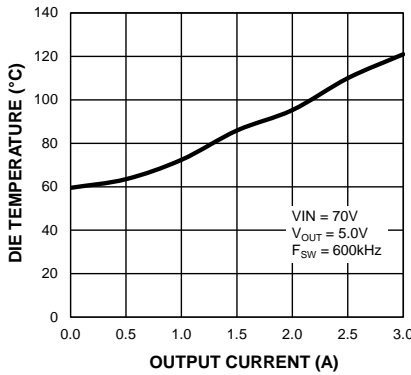

Switching Frequency

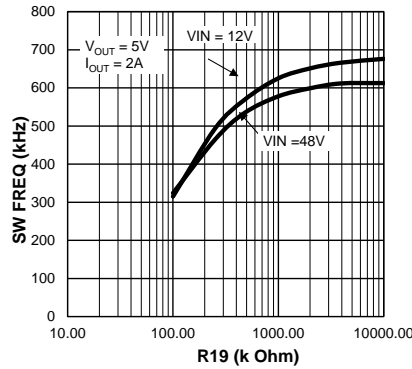

**IC Power Dissipation
vs. Output Current (MIC28304-2)**

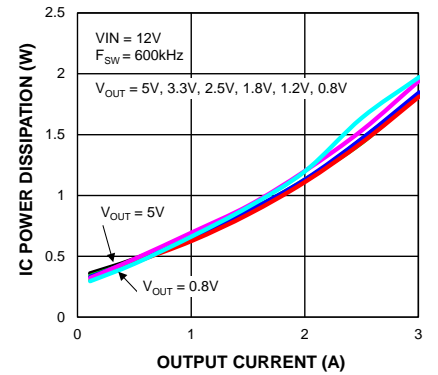

**IC Power Dissipation
vs. Output Current (MIC28304-2)**

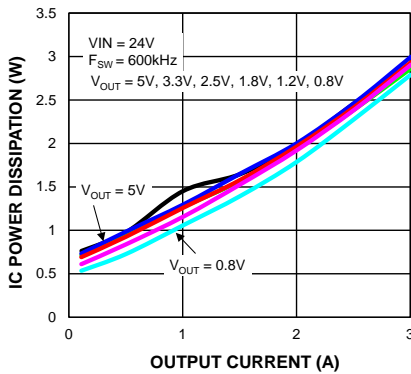

**IC Power Dissipation
vs. Output Current (MIC28304-2)**

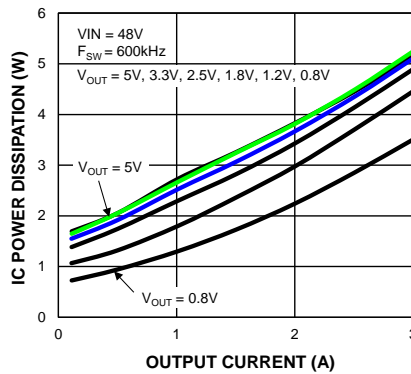

**IC Power Dissipation
vs. Output Current (MIC28304-2)**

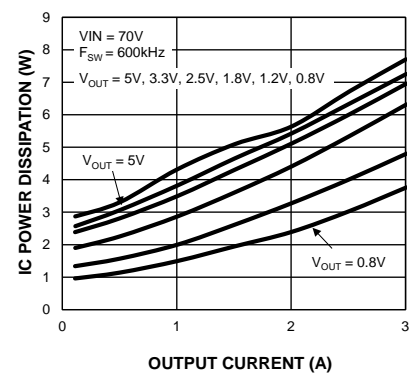

* **Case Temperature:** The temperature measurement was taken at the hottest point on the MIC28304 case mounted on a 5 square inch PCB (see Thermal Measurement section). Actual results will depend upon the size of the PCB, ambient temperature and proximity to other heat-emitting components.

Typical Characteristics (Continued)

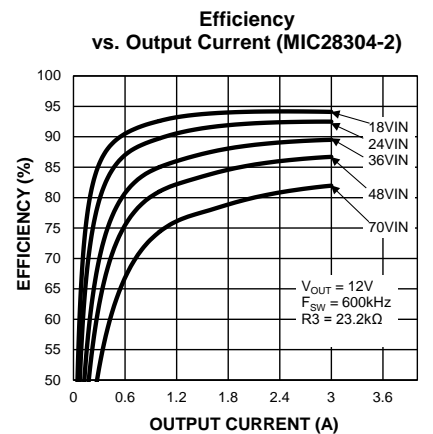
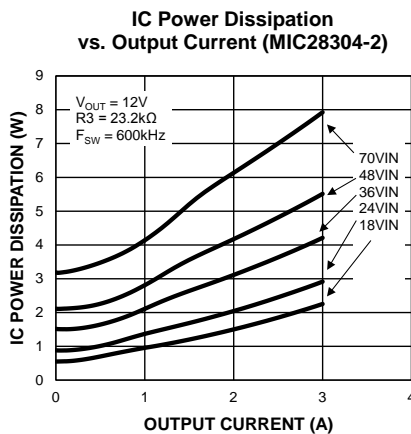
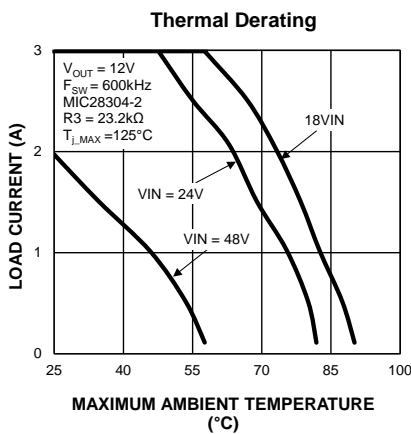
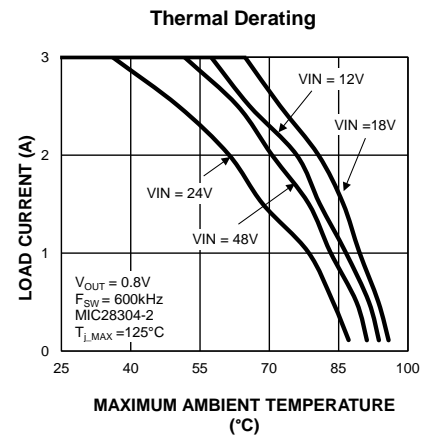
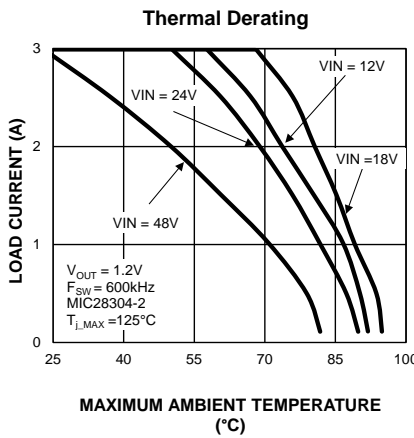
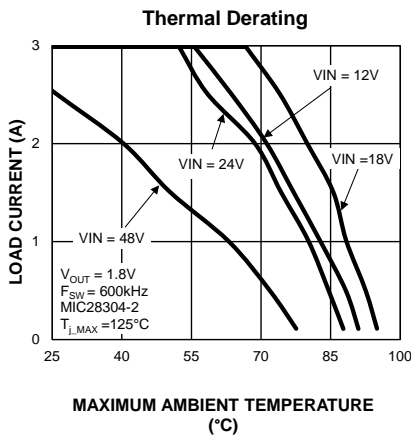
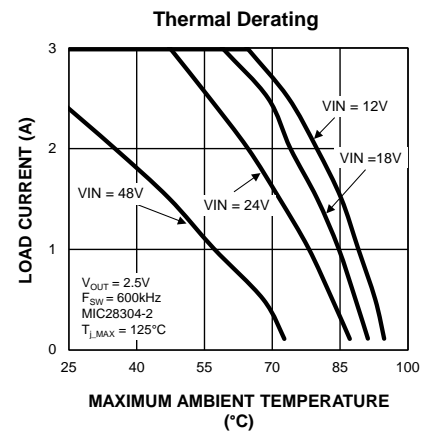
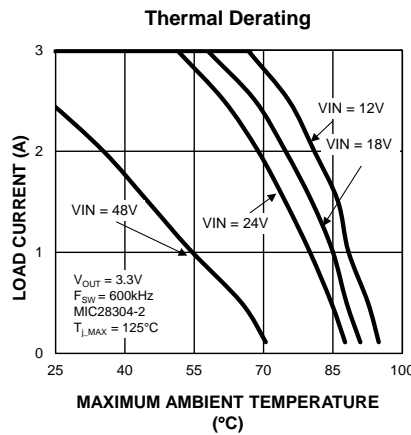
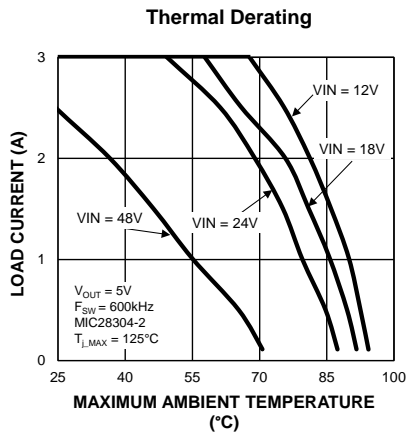

Functional Characteristics – 600kHz Switching Frequency

VIN Soft Turn-On

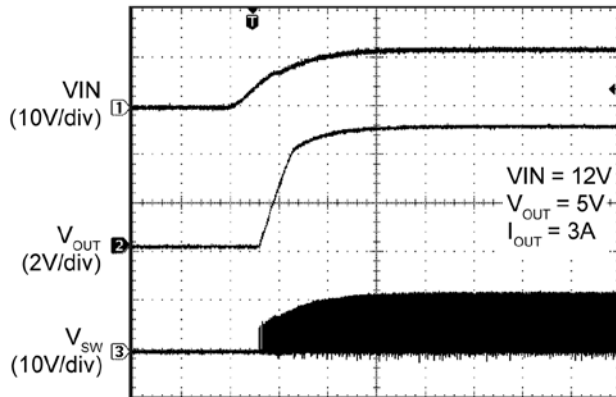

Time (4.0ms/div)

VIN Soft Turn-Off

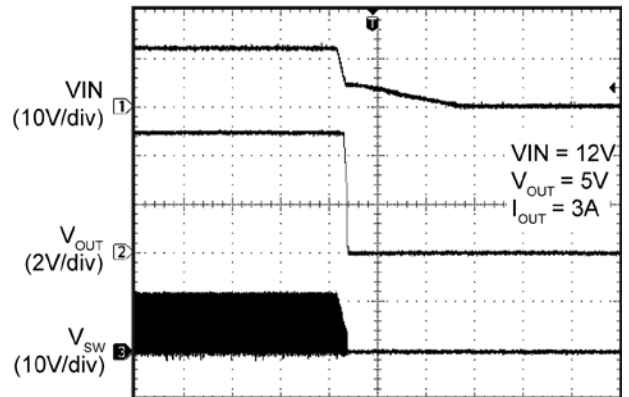

Time (20ms/div)

Enable Turn-On Delay and Rise Time

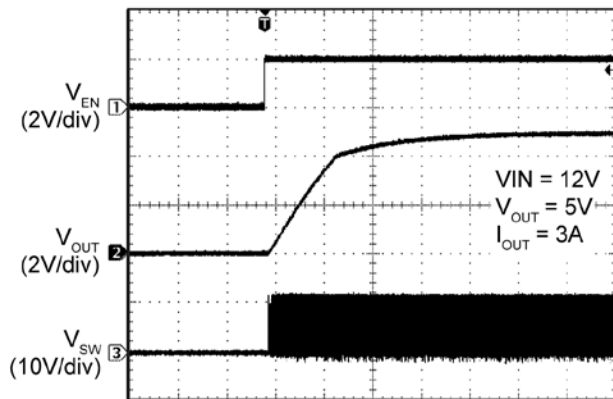

Time (2.0ms/div)

Enable Turn-Off Delay and Fall Time

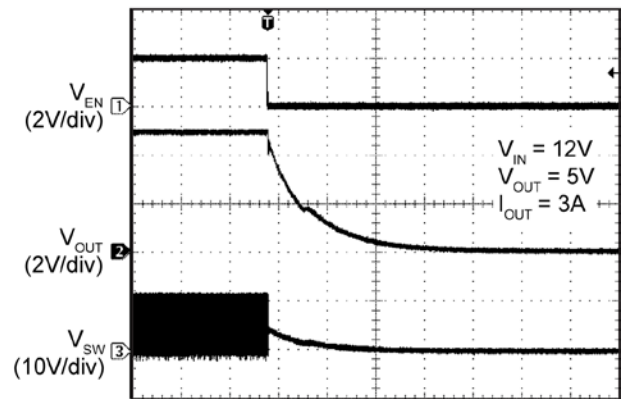

Time (1.0ms/div)

MIC28304-2 VIN Start-Up with Pre-Biased Output

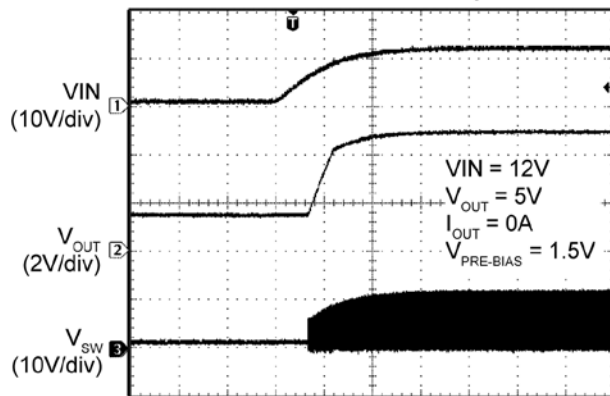

Time (4.0ms/div)

MIC28304-1 VIN Start-Up with Pre-Biased Output

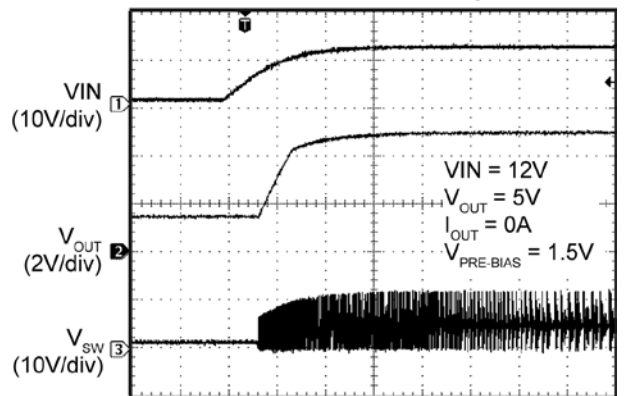

Time (4.0ms/div)

Functional Characteristics – 600kHz Switching Frequency (Continued)

Enable Turn-On/Turn-Off

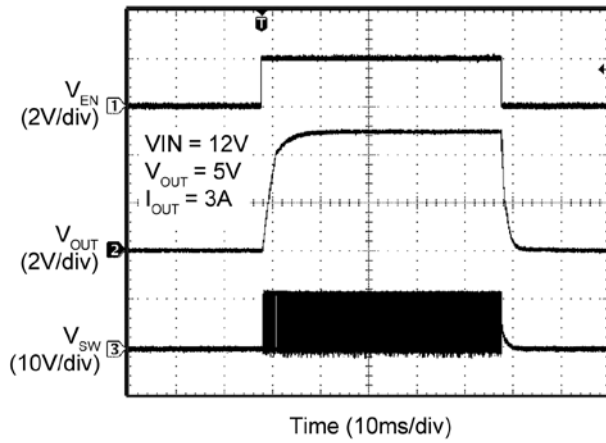

Enable Thresholds

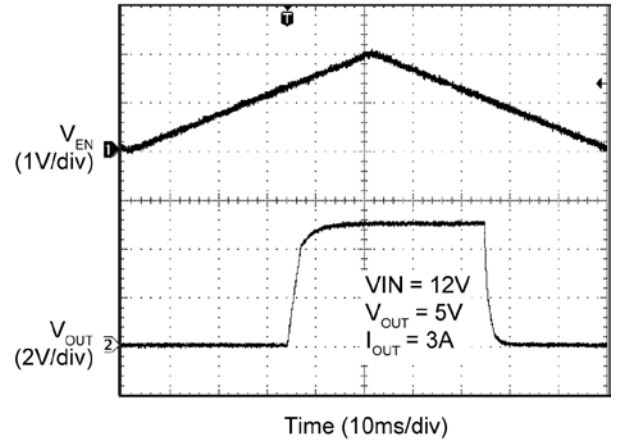

VIN UVLO Thresholds

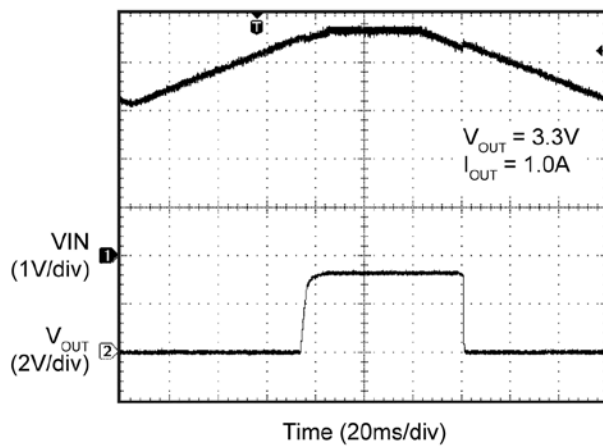

Power-Up into Short Circuit

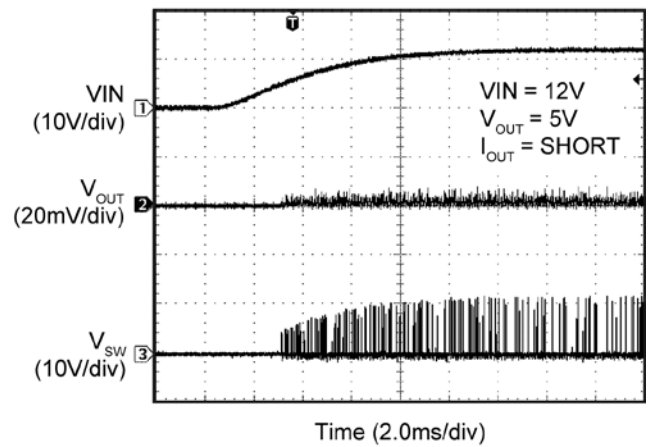

Enabled into Short

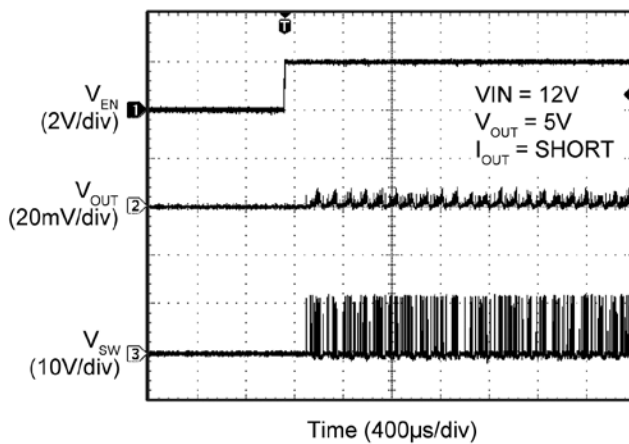

Output Peak Current-Limit Threshold

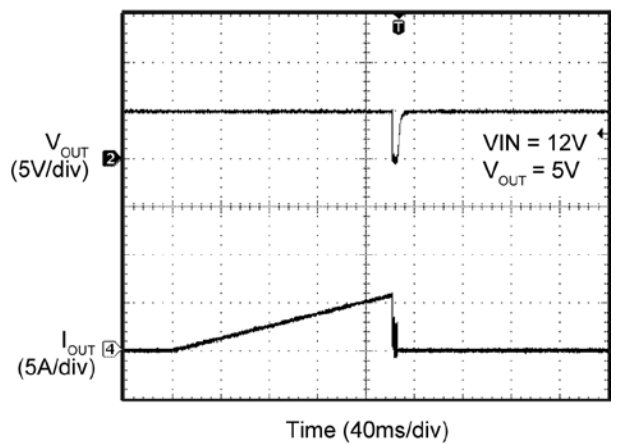

Functional Characteristics – 600kHz Switching Frequency (Continued)

Short Circuit

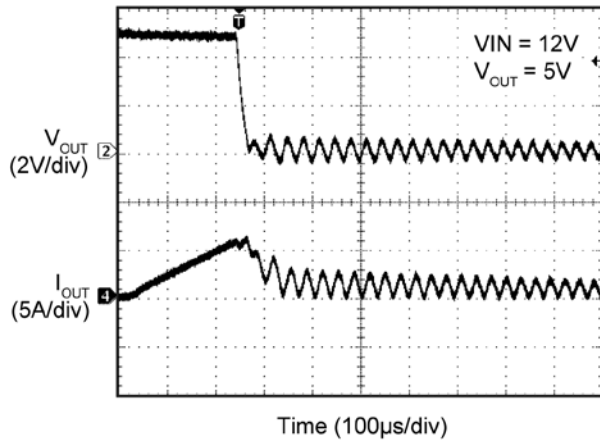

Output Recovery from Short Circuit

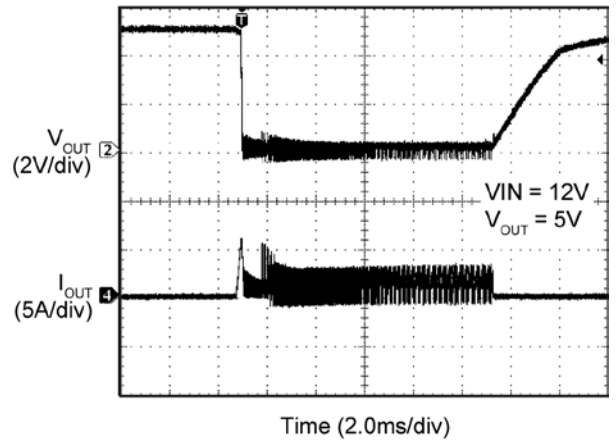

Output Recovery from Thermal Shutdown

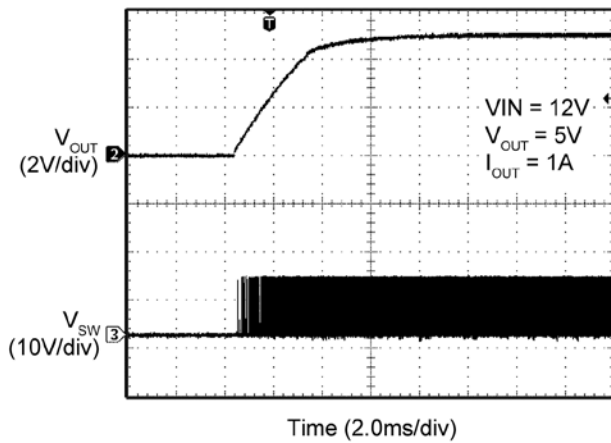

MIC28304-2 Switching Waveforms ($I_{OUT} = 3A$)

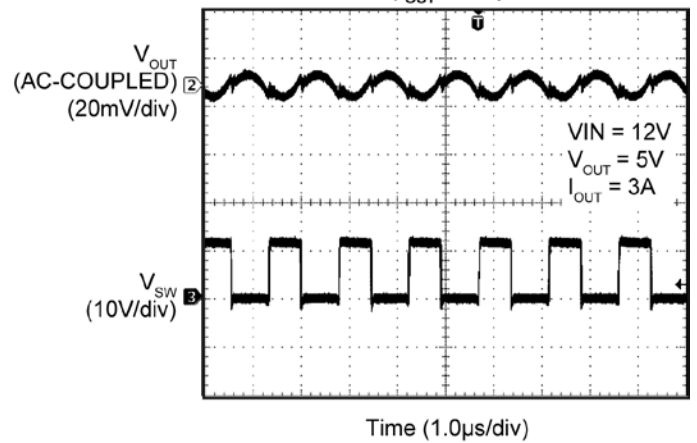

MIC28304-2 Switching Waveforms ($I_{OUT} = 0A$)

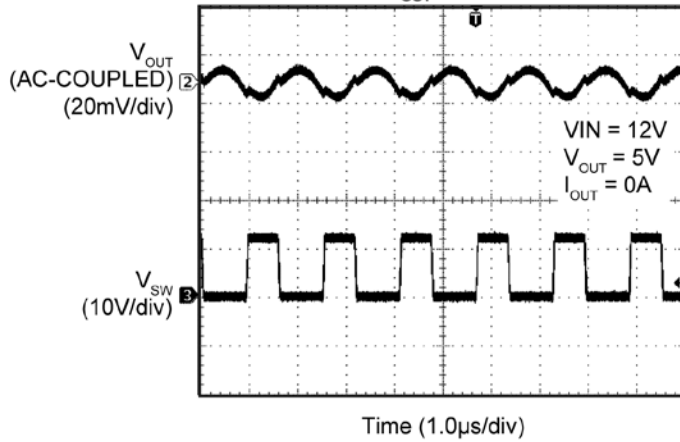

MIC28304-1 Switching Waveforms ($I_{OUT} = 0A$)

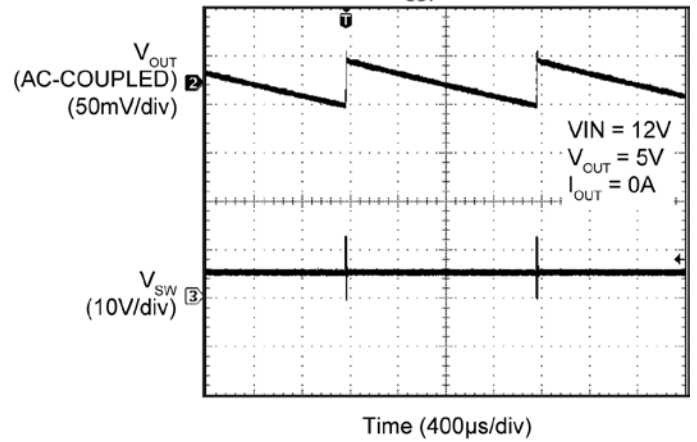

Functional Characteristics – 600kHz Switching Frequency (Continued)

MIC28304-1 Switching Waveforms
($I_{OUT} = 3A$)

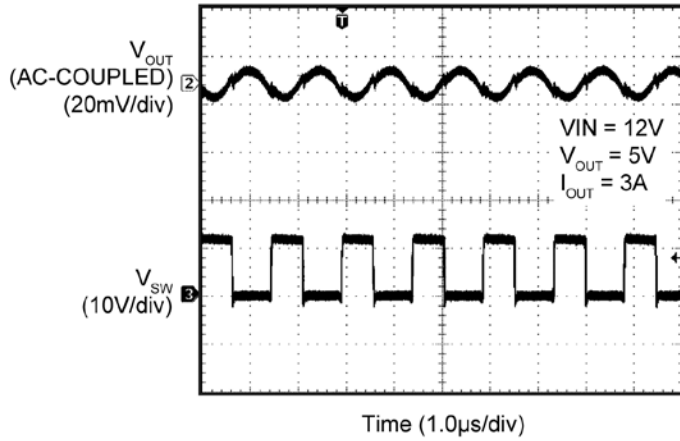

MIC28304-2 Transient Response

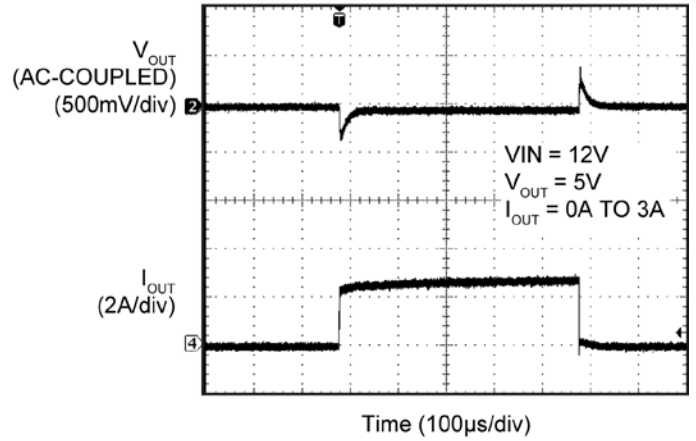

MIC28304-1 Transient Response

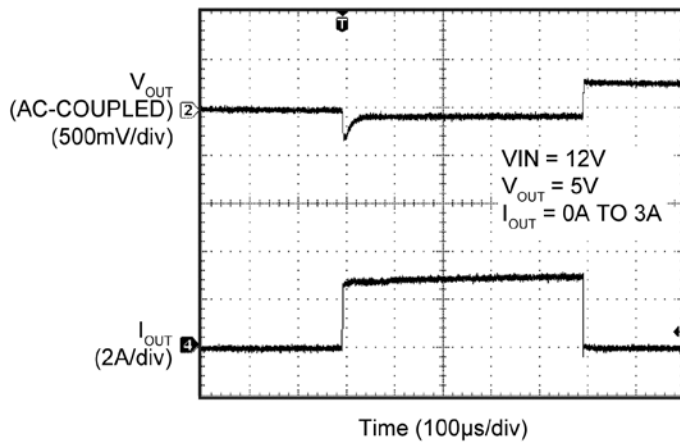

MIC28304-2 Transient Response

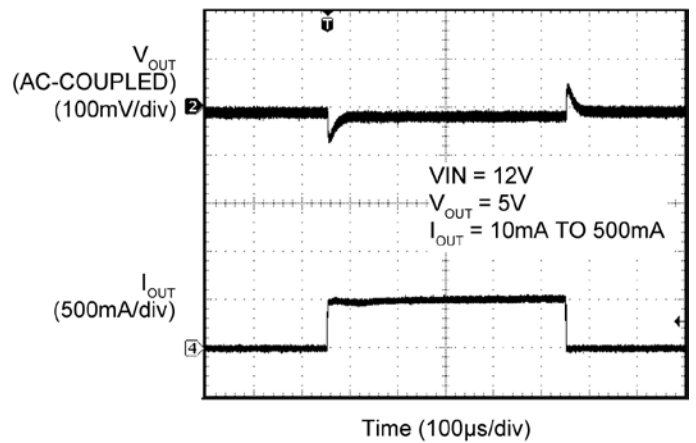

MIC28304-1 Transient Response

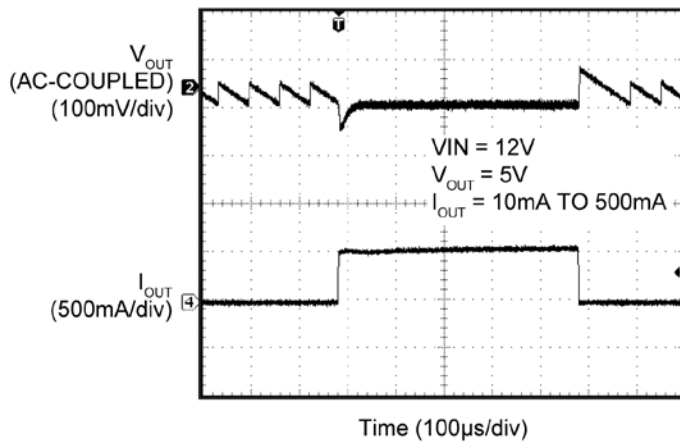

MIC28304-2 Transient Response

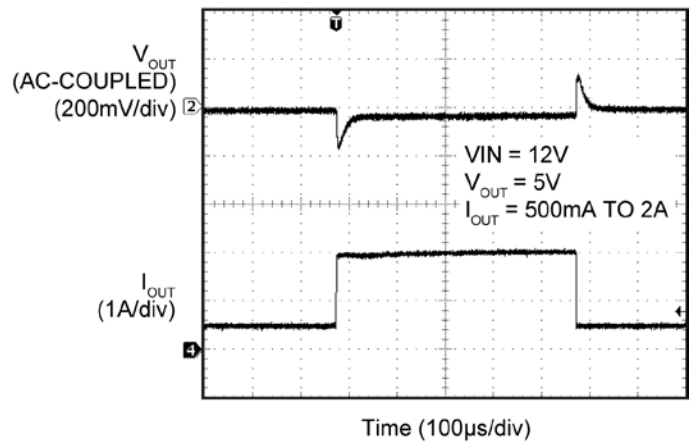

Functional Characteristics – 600kHz Switching Frequency (Continued)

MIC28304-1 Transient Response

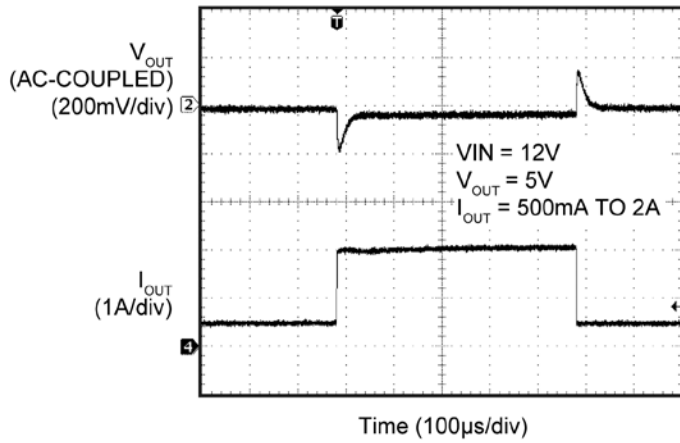

MIC28304-2 Transient Response

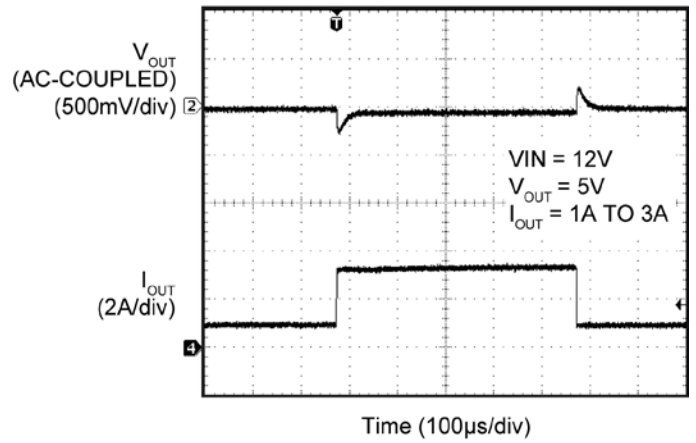

MIC28304-1 Transient Response

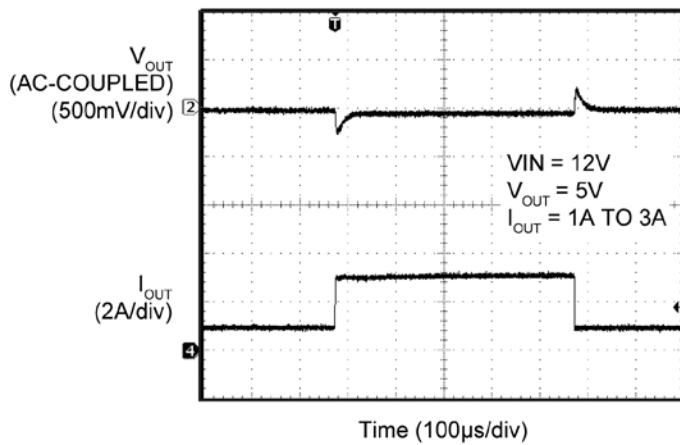

Power Good @ VIN Soft Turn-On

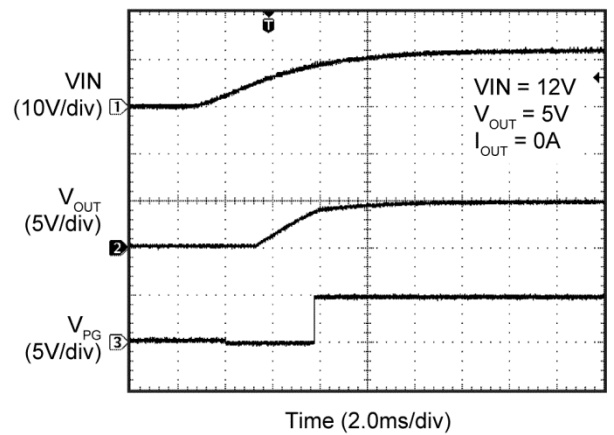

Power Good @ VIN Soft Turn-Off

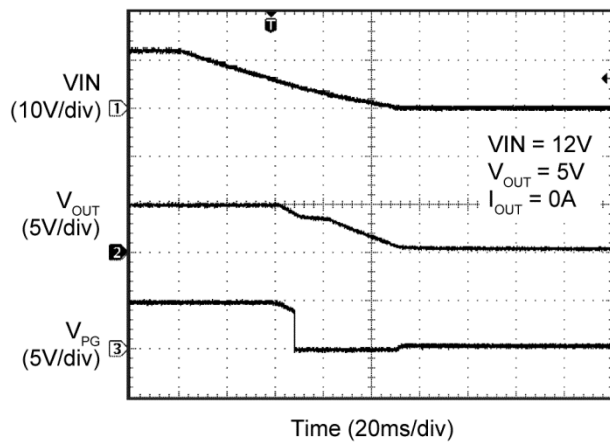

Functional Characteristics

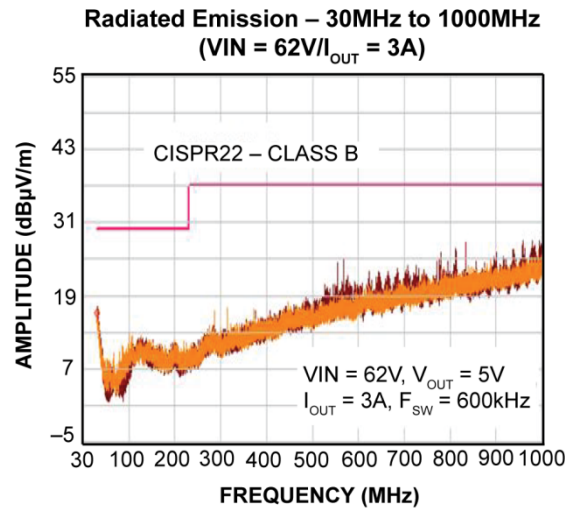
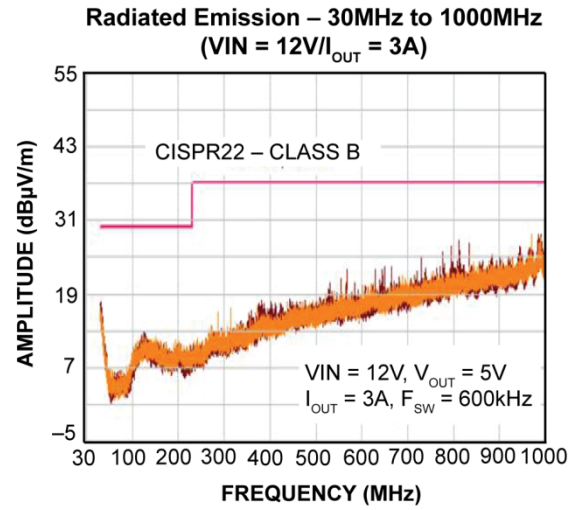
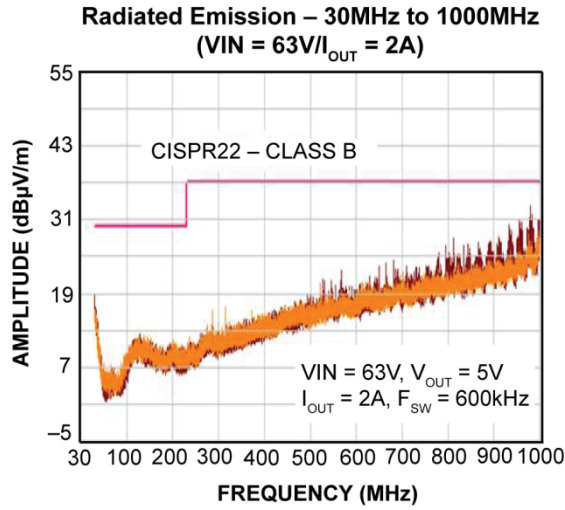
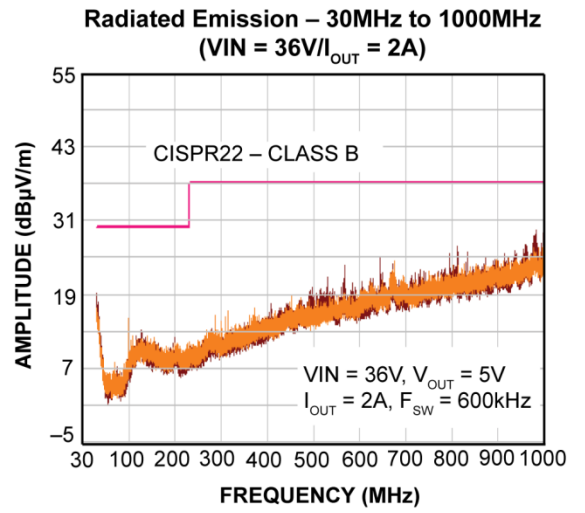
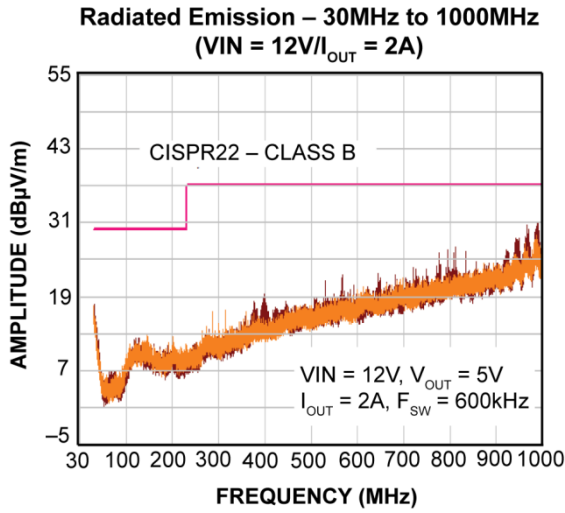

Functional Diagram

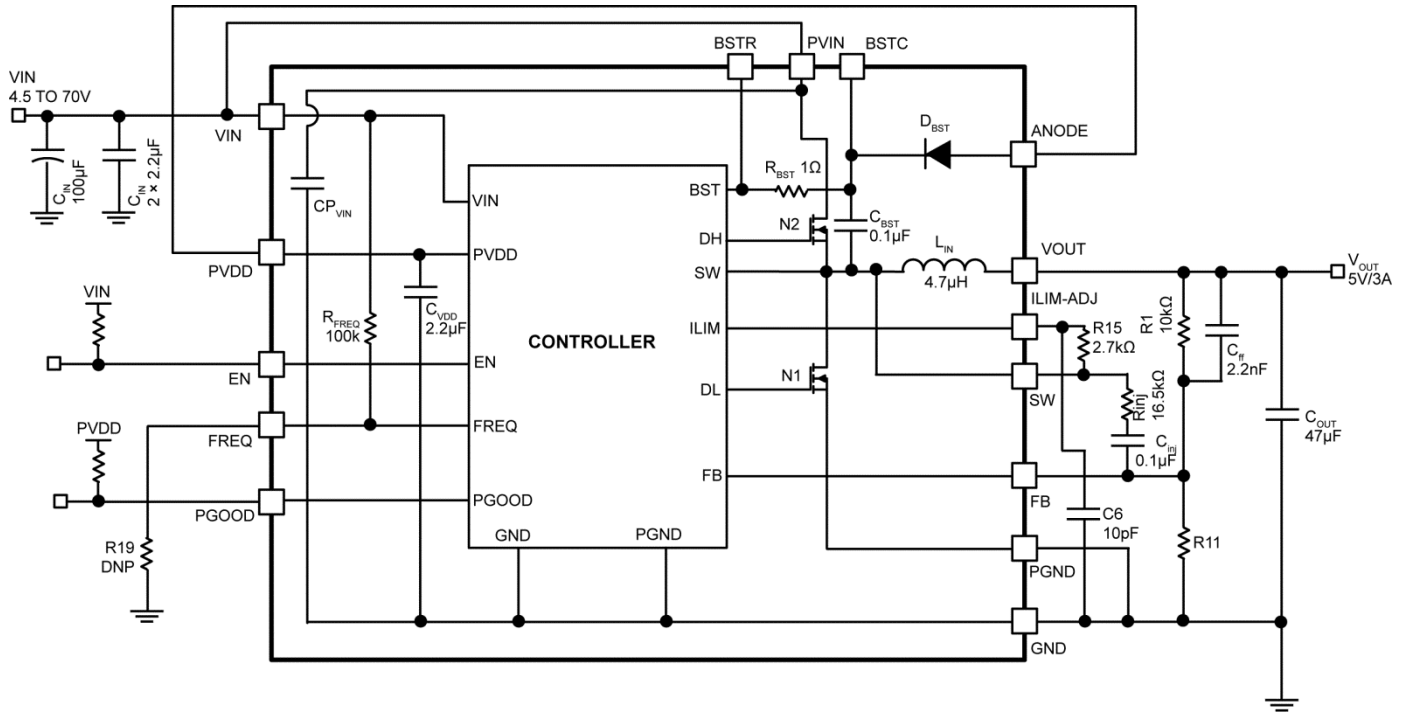

Functional Description

The MIC28304 is an adaptive on-time synchronous buck regulator module built for high-input voltage to low-output voltage conversion applications. The MIC28304 is designed to operate over a wide input voltage range, from 4.5V to 70V, and the output is adjustable with an external resistor divider. An adaptive on-time control scheme is employed to obtain a constant switching frequency and to simplify the control compensation. Hiccup mode over-current protection is implemented by sensing low-side MOSFET's $R_{DS(ON)}$. The device features internal soft-start, enable, UVLO, and thermal shutdown. The module has integrated switching FETs, inductor, bootstrap diode, resistor and capacitor.

Theory of Operation

Per the *Functional Diagram* of the MIC28304 module, the output voltage is sensed by the MIC28304 feedback pin FB via the voltage divider R1 and R11, and compared to a 0.8V reference voltage VREF at the error comparator through a low-gain transconductance (g_m) amplifier. If the feedback voltage decreases and the amplifier output is below 0.8V, then the error comparator will trigger the control logic and generate an ON-time period. The ON-time period length is predetermined by the "Fixed tON Estimator" circuitry:

$$t_{ON(ESTIMATED)} = \frac{V_{OUT}}{V_{IN} \times f_{SW}} \quad \text{Eq. 1}$$

where V_{OUT} is the output voltage, V_{IN} is the power stage input voltage, and f_{SW} is the switching frequency.

At the end of the ON-time period, the internal high-side driver turns off the high-side MOSFET and the low-side driver turns on the low-side MOSFET. The OFF-time period length depends upon the feedback voltage in most cases. When the feedback voltage decreases and the output of the g_m amplifier is below 0.8V, the ON-time period is triggered and the OFF-time period ends. If the OFF-time period determined by the feedback voltage is less than the minimum OFF-time $t_{OFF(MIN)}$, which is about 200ns, the MIC28304 control logic will apply the $t_{OFF(MIN)}$ instead. $t_{OFF(MIN)}$ is required to maintain enough energy in the boost capacitor (C_{BST}) to drive the high-side MOSFET.

The maximum duty cycle is obtained from the 200ns $t_{OFF(MIN)}$:

$$D_{MAX} = \frac{t_S - t_{OFF(MIN)}}{t_S} = 1 - \frac{200ns}{t_S} \quad \text{Eq. 2}$$

Where:

$t_S = 1/f_{SW}$. It is not recommended to use MIC28304 with an OFF-time close to $t_{OFF(MIN)}$ during steady-state operation.

The adaptive ON-time control scheme results in a constant switching frequency in the MIC28304. The actual ON-time and resulting switching frequency will vary with the different rising and falling times of the external MOSFETs. Also, the minimum t_{ON} results in a lower switching frequency in high V_{IN} to V_{OUT} applications. During load transients, the switching frequency is changed due to the varying OFF-time.

To illustrate the control loop operation, we will analyze both the steady-state and load transient scenarios. For easy analysis, the gain of the g_m amplifier is assumed to be 1. With this assumption, the inverting input of the error comparator is the same as the feedback voltage.

Figure 1 shows the MIC28304 control loop timing during steady-state operation. During steady-state, the g_m amplifier senses the feedback voltage ripple, which is proportional to the output voltage ripple plus injected voltage ripple, to trigger the ON-time period. The ON-time is predetermined by the t_{ON} estimator. The termination of the OFF-time is controlled by the feedback voltage. At the valley of the feedback voltage ripple, which occurs when V_{FB} falls below V_{REF} , the OFF period ends and the next ON-time period is triggered through the control logic circuitry.

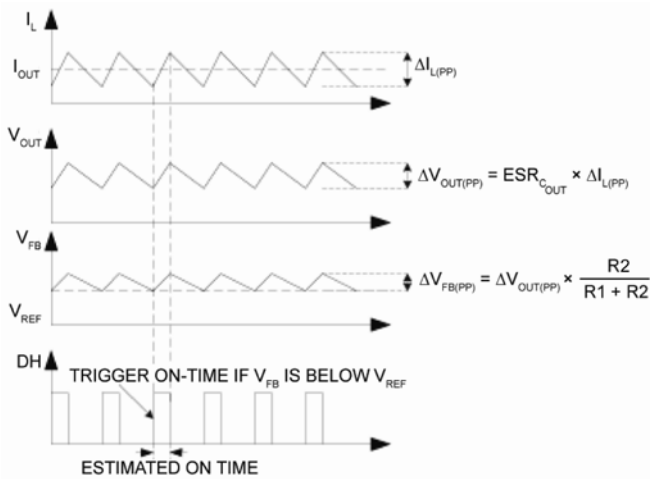

Figure 1. MIC28304 Control Loop Timing

Figure 2 shows the operation of the MIC28304 during a load transient. The output voltage drops due to the sudden load increase, which causes the V_{FB} to be less than V_{REF} . This will cause the error comparator to trigger an ON-time period. At the end of the ON-time period, a minimum OFF-time $t_{OFF(MIN)}$ is generated to charge the bootstrap capacitor (C_{BST}) since the feedback voltage is still below V_{REF} . Then, the next ON-time period is triggered due to the low feedback voltage. Therefore, the switching frequency changes during the load transient, but returns to the nominal fixed frequency once the output has stabilized at the new load current level. With the varying duty cycle and switching frequency, the output recovery time is fast and the output voltage deviation is small.

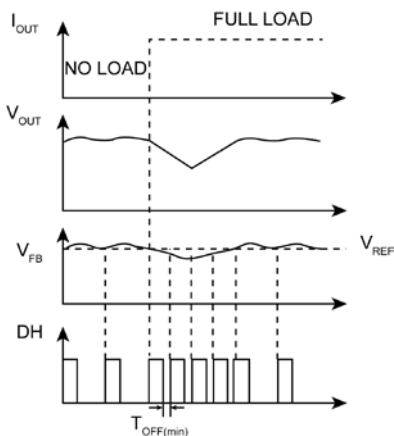

Figure 2. MIC28304 Load Transient Response

Unlike true current-mode control, the MIC28304 uses the output voltage ripple to trigger an ON-time period. The output voltage ripple is proportional to the inductor current ripple if the ESR of the output capacitor is large enough.

In order to meet the stability requirements, the MIC28304 feedback voltage ripple should be in phase with the inductor current ripple and are large enough to be sensed by the g_m amplifier and the error comparator. The recommended feedback voltage ripple is 20mV~100mV over full input voltage range. If a low ESR output capacitor is selected, then the feedback voltage ripple may be too small to be sensed by the g_m amplifier and the error comparator. Also, the output voltage ripple and the feedback voltage ripple are not necessarily in phase with the inductor current ripple if the ESR of the output capacitor is very low. In these cases, ripple injection is required to ensure proper operation. Please refer to “Ripple Injection” subsection in [Application Information](#) for more details about the ripple injection technique.

Discontinuous Mode (MIC28304-1 only)

In continuous mode, the inductor current is always greater than zero; however, at light loads, the MIC28304-1 is able to force the inductor current to operate in discontinuous mode. Discontinuous mode is where the inductor current falls to zero, as indicated by trace (I_L) shown in [Figure 3](#). During this period, the efficiency is optimized by shutting down all the non-essential circuits and minimizing the supply current. The MIC28304-1 wakes up and turns on the high-side MOSFET when the feedback voltage V_{FB} drops below 0.8V.

The MIC28304-1 has a zero crossing comparator (ZC) that monitors the inductor current by sensing the voltage drop across the low-side MOSFET during its ON-time. If the $V_{FB} > 0.8V$ and the inductor current goes slightly negative, then the MIC28304-1 automatically powers down most of the IC circuitry and goes into a low-power mode.

Once the MIC28304-1 goes into discontinuous mode, both DL and DH are low, which turns off the high-side and low-side MOSFETs. The load current is supplied by the output capacitors and V_{OUT} drops. If the drop of V_{OUT} causes V_{FB} to go below V_{REF} , then all the circuits will wake up into normal continuous mode. First, the bias currents of most circuits reduced during the discontinuous mode are restored, and then a t_{ON} pulse is triggered before the drivers are turned on to avoid any possible glitches. Finally, the high-side driver is turned on. [Figure 3](#) shows the control loop timing in discontinuous mode.

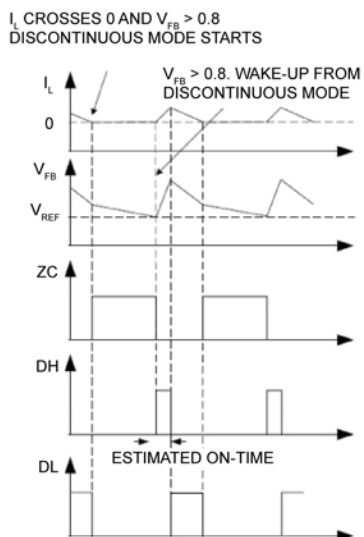

Figure 3. MIC28302-1 Control Loop Timing (Discontinuous Mode)

During discontinuous mode, the bias current of most circuits is substantially reduced. As a result, the total power supply current during discontinuous mode is only about 400µA, allowing the MIC28304-1 to achieve high efficiency in light load applications.

Soft-Start

Soft-start reduces the input power supply surge current at startup by controlling the output voltage rise time. The input surge appears while the output capacitor is charged up. A slower output rise time will draw a lower input surge current.

The MIC28304 implements an internal digital soft-start by making the 0.8V reference voltage V_{REF} ramp from 0 to 100% in about 5ms with 9.7mV steps. Therefore, the output voltage is controlled to increase slowly by a staircase V_{FB} ramp. Once the soft-start cycle ends, the related circuitry is disabled to reduce current consumption. PVDD must be powered up at the same time or after V_{IN} to make the soft-start function correctly.

Current Limit

The MIC28304 uses the $R_{DS(ON)}$ of the low side MOSEFET and external resistor connected from ILIM pin to SW node to decide the current limit.

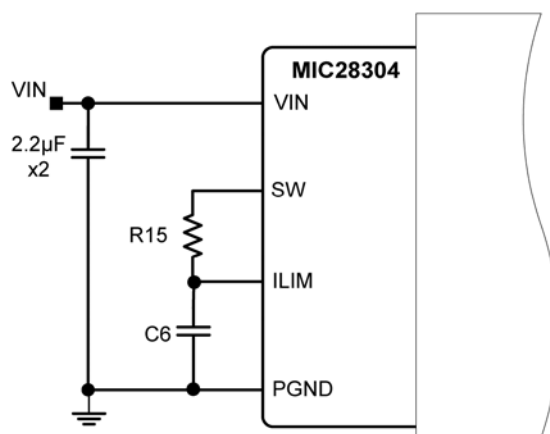

Figure 4. MIC28304 Current-Limiting Circuit

In each switching cycle of the MIC28304, the inductor current is sensed by monitoring the low-side MOSFET in the OFF period. The sensed voltage $V(ILIM)$ is compared with the power ground (PGND) after a blanking time of 150ns. In this way the drop voltage over the resistor R15 (V_{CL}) is compared with the drop over the bottom FET generating the short current limit. The small capacitor (C6) connected from ILIM pin to PGND filters the switching node ringing during the off-time allowing a better short limit measurement. The time constant created by R15 and C6 should be much less than the minimum off time.

The V_{CL} drop allows programming of short limit through the value of the resistor (R15), If the absolute value of the voltage drop on the bottom FET is greater than V_{CL} . In that case the $V(ILIM)$ is lower than PGND and a short circuit event is triggered. A hiccup cycle to treat the short event is generated. The hiccup sequence including the soft start reduces the stress on the switching FETs and protects the load and supply for severe short conditions.

The short-circuit current limit can be programmed by using Equation 3.

$$R15 = \frac{(I_{CLIM} - \Delta I_{L(PP)} \times 0.5) \times R_{DS(ON)} + V_{CL}}{I_{CL}} \quad \text{Eq. 3}$$

Where:

I_{CLIM} = Desired current limit

$R_{DS(ON)}$ = On-resistance of low-side power MOSFET, 57m Ω typically

V_{CL} = Current-limit threshold (typical absolute value is 14mV per the [Electrical Characteristics](#)⁽⁴⁾)

I_{CL} = Current-limit source current (typical value is 80 μ A, per the Electrical Characteristics table).

$\Delta I_{L(PP)}$ = Inductor current peak-to-peak, since the inductor is integrated use Equation 4 to calculate the inductor ripple current.

The peak-to-peak inductor current ripple is:

$$\Delta I_{L(PP)} = \frac{V_{OUT} \times (V_{IN(max)} - V_{OUT})}{V_{IN(max)} \times f_{sw} \times L} \quad \text{Eq. 4}$$

The MIC28304 has 4.7 μ H inductor integrated into the module. The typical value of $R_{WINDING(DCR)}$ of this particular inductor is in the range of 45m Ω .

In case of hard short, the short limit is folded down to allow an indefinite hard short on the output without any destructive effect. It is mandatory to make sure that the inductor current used to charge the output capacitance during soft start is under the folded short limit; otherwise the supply will go in hiccup mode and may not be finishing the soft start successfully.

The MOSFET $R_{DS(ON)}$ varies 30% to 40% with temperature; therefore, it is recommended to add a 50% margin to I_{CLIM} in Equation 3 to avoid false current limiting due to increased MOSFET junction temperature rise. [Table 2](#) shows typical output current limit value for a given R15 with C6 = 10pF.

Table 2. Typical Output Current-Limit Value

R15	Typical Output Current Limit
1.81k Ω	3A
2.7k Ω	6.3A

Application Information

Simplified Input Transient Circuitry

The 76V absolute maximum rating of MIC28304 allows simplifying the transient voltage suppressor on the input supply side which is very common in industrial applications. The input supply voltage V_{IN} Figure 5 may be operating at 12V input rail most of the time, but can encounter noise spike of 60V for a short duration. By using MIC28304, which has 76V absolute maximum voltage rating, the input transient suppressor is not needed. Which saves on component count, form factor, and ultimately the system becomes less expensive.

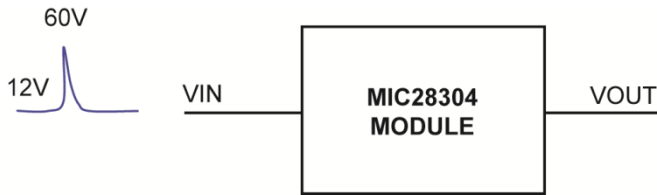

Figure 5. Simplified Input Transient Circuitry

Setting the Switching Frequency

The MIC28304 switching frequency can be adjusted by changing the value of resistor R19. The top resistor of 100kΩ is internal to module and is connected between VIN and FREQ pin, so the value of R19 sets the switching frequency. The switching frequency also depends upon VIN, V_{OUT} and load conditions.

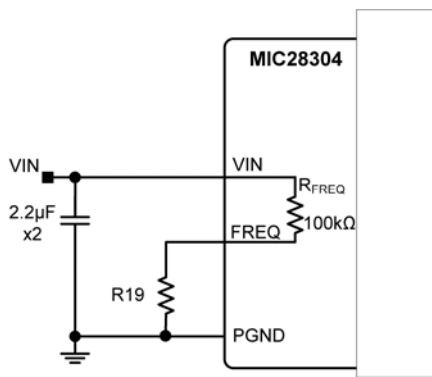

Figure 6. Switching Frequency Adjustment

Equation 5 gives the estimated switching frequency:

$$f_{SW_ADJ} = f_O \times \frac{R19}{R19 + 100k\Omega} \tag{Eq. 5}$$

Where:

f_O = Switching frequency when R19 is open

For more precise setting, it is recommended to use Figure 7:

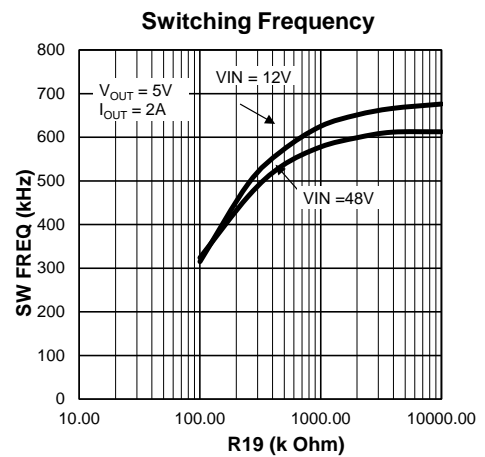

Figure 7. Switching Frequency vs. R19

Output Capacitor Selection

The type of the output capacitor is usually determined by the application and its equivalent series resistance (ESR). Voltage and RMS current capability are two other important factors for selecting the output capacitor. Recommended capacitor types are MLCC, tantalum, low-ESR aluminum electrolytic, OS-CON and POSCAP. The output capacitor's ESR is usually the main cause of the output ripple. The MIC28304 requires ripple injection and the output capacitor ESR effects the control loop from a stability point of view.

The maximum value of ESR is calculated as in Equation 6:

$$ESR_{C_{OUT}} \leq \frac{\Delta V_{OUT(pp)}}{\Delta I_{L(pp)}} \quad \text{Eq. 6}$$

Where:

$\Delta V_{OUT(pp)}$ = Peak-to-peak output voltage ripple

$\Delta I_{L(pp)}$ = Peak-to-peak inductor current ripple

The total output ripple is a combination of the ESR and output capacitance. The total ripple is calculated in Equation 7:

$$\Delta V_{OUT(pp)} = \sqrt{\left(\frac{\Delta I_{L(pp)}}{C_{OUT} \times f_{SW} \times 8}\right)^2 + (\Delta I_{L(pp)} \times ESR_{C_{OUT}})^2} \quad \text{Eq. 7}$$

Where:

D = Duty cycle

C_{OUT} = Output capacitance value

f_{sw} = Switching frequency

As described in the “[Theory of Operation](#)” subsection in [Functional Description](#), the MIC28304 requires at least 20mV peak-to-peak ripple at the FB pin to make the g_m amplifier and the error comparator behave properly. Also, the output voltage ripple should be in phase with the inductor current. Therefore, the output voltage ripple caused by the output capacitors value should be much smaller than the ripple caused by the output capacitor ESR. If low-ESR capacitors, such as ceramic capacitors, are selected as the output capacitors, a ripple injection method should be applied to provide enough feedback voltage ripple. Please refer to the “Ripple Injection” subsection for more details.

The voltage rating of the capacitor should be twice the output voltage for a tantalum and 20% greater for aluminum electrolytic or OS-CON.

The output capacitor RMS current is calculated in Equation 8:

$$I_{C_{OUT}(RMS)} = \frac{\Delta I_{L(pp)}}{\sqrt{12}} \quad \text{Eq. 8}$$

The power dissipated in the output capacitor is:

$$P_{DISS(C_{OUT})} = I_{C_{OUT}(RMS)}^2 \times ESR_{C_{OUT}} \quad \text{Eq. 9}$$

Input Capacitor Selection

The input capacitor for the power stage input PVIN should be selected for ripple current rating and voltage rating. Tantalum input capacitors may fail when subjected to high inrush currents, caused by turning the input supply on. A tantalum input capacitor’s voltage rating should be at least two times the maximum input voltage to maximize reliability. Aluminum electrolytic, OS-CON, and multilayer polymer film capacitors can handle the higher inrush currents without voltage de-rating. The input voltage ripple will primarily depend on the input capacitor’s ESR. The peak input current is equal to the peak inductor current, so:

$$\Delta V_{IN} = I_{L(pk)} \times ESR_{C_{IN}} \quad \text{Eq. 10}$$

The input capacitor must be rated for the input current ripple. The RMS value of input capacitor current is determined at the maximum output current. Assuming the peak-to-peak inductor current ripple is low:

$$I_{C_{IN}(RMS)} \approx I_{OUT(max)} \times \sqrt{D \times (1-D)} \quad \text{Eq. 11}$$

The power dissipated in the input capacitor is:

$$P_{DISS(C_{IN})} = I_{C_{IN}(RMS)}^2 \times ESR_{C_{IN}} \quad \text{Eq. 12}$$

The general rule is to pick the capacitor with a ripple current rating equal to or greater than the calculated worst ($V_{IN,MAX}$) case RMS capacitor current. Its voltage rating should be 20% to 50% higher than the maximum input voltage. Typically the input ripple (dV) needs to be kept down to less than $\pm 10\%$ of input voltage. The ESR also increases the input ripple.

Equation 13 should be used to calculate the input capacitor. Also it is recommended to keep some margin on the calculated value:

$$C_{IN} \approx \frac{I_{OUT(max)} \times (1-D)}{F_{SW} \times dV} \quad \text{Eq. 13}$$

Where:

dV = The input ripple and F_{SW} is the switching frequency

Output Voltage Setting Components

The MIC28304 requires two resistors to set the output voltage as shown in Figure 8:

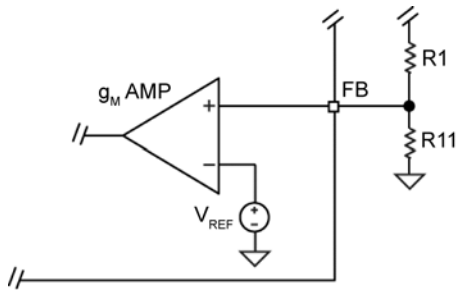

Figure 8. Voltage-Divider Configuration

The output voltage is determined by Equation 14:

$$V_{OUT} = V_{FB} \times \left(1 + \frac{R1}{R11}\right) \quad \text{Eq. 14}$$

Where:

$V_{FB} = 0.8V$

A typical value of R1 used on the standard evaluation board is 10kΩ. If R1 is too large, it may allow noise to be introduced into the voltage feedback loop. If R1 is too small in value, it will decrease the efficiency of the power supply, especially at light loads. Once R1 is selected, R11 can be calculated using Equation 15:

$$R11 = \frac{V_{FB} \times R1}{V_{OUT} - V_{FB}} \quad \text{Eq. 15}$$

Ripple Injection

The V_{FB} ripple required for proper operation of the MIC28304 g_M amplifier and error comparator is 20mV to 100mV. However, the output voltage ripple is generally designed as 1% to 2% of the output voltage. For a low output voltage, such as a 1V, the output voltage ripple is only 10mV to 20mV, and the feedback voltage ripple is less than 20mV. If the feedback voltage ripple is so small that the g_M amplifier and error comparator cannot sense it, then the MIC28304 will lose control and the output voltage is not regulated. In order to have some amount of V_{FB} ripple, a ripple injection method is applied for low output voltage ripple applications. The table 2 summarizes the ripple injection component values for ceramic output capacitor.

The applications are divided into three situations according to the amount of the feedback voltage ripple:

1. Enough ripple at the feedback voltage due to the large ESR of the output capacitors (Figure 9):

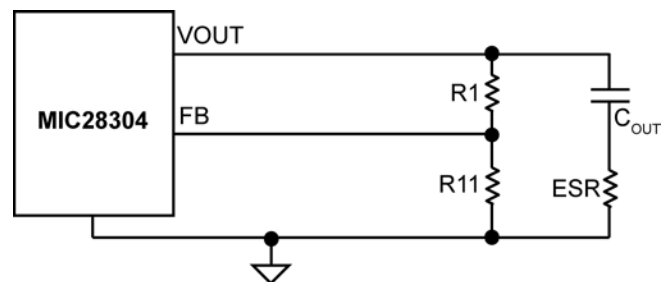

Figure 9. Enough Ripple at FB

As shown in Figure 10, the converter is stable without any ripple injection.

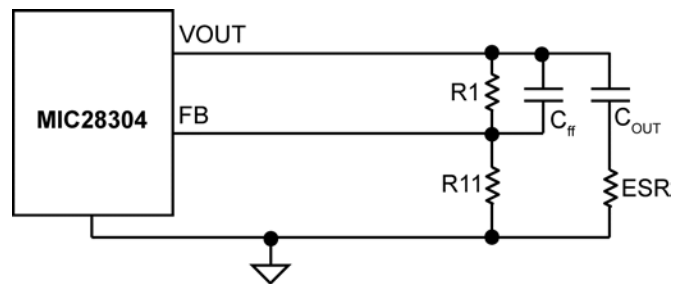

Figure 10. Inadequate Ripple at FB

The feedback voltage ripple is:

$$\Delta V_{FB(PP)} = \frac{R11}{R1 + R11} \times ESR_{C_{OUT}} \times \Delta I_{L(PP)} \quad \text{Eq. 16}$$

Where:

$\Delta I_{L(PP)}$ = The peak-to-peak value of the inductor current ripple

- Inadequate ripple at the feedback voltage due to the small ESR of the output capacitors, such is the case with ceramic output capacitor.

The output voltage ripple is fed into the FB pin through a feed-forward capacitor C_{ff} in this situation, as shown in Figure 11. The typical C_{ff} value is between 1nF and 100nF.

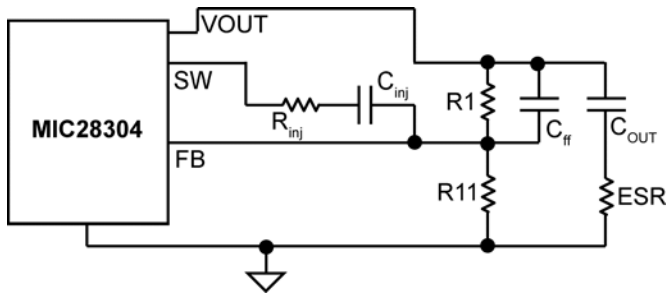

Figure 11. Invisible Ripple at FB

With the feed-forward capacitor, the feedback voltage ripple is very close to the output voltage ripple:

$$\Delta V_{FB(PP)} \approx ESR \times \Delta I_{L(PP)} \quad \text{Eq. 17}$$

- Virtually no ripple at the FB pin voltage due to the very-low ESR of the output capacitors.

In this situation, the output voltage ripple is less than 20mV. Therefore, additional ripple is injected into the FB pin from the switching node SW via a resistor R_{inj} and a capacitor C_{inj} , as shown in Figure 11. The injected ripple is:

$$\Delta V_{FB(PP)} = V_{IN} \times K_{div} \times D \times (1-D) \times \frac{1}{f_{SW} \times \tau} \quad \text{Eq. 18}$$

$$K_{div} = \frac{R1//R11}{R_{inj} + R1//R11} \quad \text{Eq. 19}$$

Where:

V_{IN} = Power stage input voltage

D = Duty cycle

f_{SW} = Switching frequency

$\tau = (R1//R11//R_{inj}) \times C_{ff}$

In Equations 18 and 19, it is assumed that the time constant associated with C_{ff} must be much greater than the switching period:

$$\frac{1}{f_{SW} \times \tau} = \frac{T}{\tau} \ll 1 \quad \text{Eq. 20}$$

If the voltage divider resistors R1 and R11 are in the k Ω range, then a C_{ff} of 1nF to 100nF can easily satisfy the large time constant requirements. Also, a 100nF injection capacitor C_{inj} is used in order to be considered as short for a wide range of the frequencies.

The process of sizing the ripple injection resistor and capacitors is:

Step 1. Select C_{ff} to feed all output ripples into the feedback pin and make sure the large time constant assumption is satisfied. Typical choice of C_{ff} is 1nF to 100nF if R1 and R11 are in k Ω range.

Step 2. Select R_{inj} according to the expected feedback voltage ripple using Equation 22:

$$K_{div} = \frac{\Delta V_{FB(PP)}}{V_{IN}} \times \frac{f_{SW} \times \tau}{D \times (1-D)} \quad \text{Eq. 21}$$

Then the value of R_{inj} is obtained as:

$$R_{inj} = (R1//R11) \times \left(\frac{1}{K_{div}} - 1 \right) \quad \text{Eq. 22}$$

Step 3. Select C_{inj} as 100nF, which could be considered as short for a wide range of the frequencies.

Table 3 summarizes the typical value of components for particular input and output voltage, and 600kHz switching frequency design, for details refer to the Bill of Materials section.

Table 3. Recommended Component Values for 600kHz Switching Frequency

V _{OUT}	V _{IN}	R3 (R _{inj})	R1 (Top Feedback Resistor)	R11 (Bottom Feedback Resistor)	R19	C10 (C _{inj})	C12 (C _{ff})	C _{OUT}
0.9V	5V to 70V	16.5kΩ	10kΩ	80.6kΩ	DNP	0.1μF	2.2nF	47μF/6.3V or 2 x 22μF
1.2V	5V to 70V	16.5kΩ	10kΩ	20kΩ	DNP	0.1μF	2.2nF	47μF/6.3V or 2 x 22μF
1.8V	5V to 70V	16.5kΩ	10kΩ	8.06kΩ	DNP	0.1μF	2.2nF	47μF/6.3V or 2 x 22μF
2.5V	5V to 70V	16.5kΩ	10kΩ	4.75kΩ	DNP	0.1μF	2.2nF	47μF/6.3V or 2 x 22μF
3.3V	5V to 70V	16.5kΩ	10kΩ	3.24kΩ	DNP	0.1μF	2.2nF	47μF/6.3V or 2 x 22μF
5V	7V to 70V	16.5kΩ	10kΩ	1.9kΩ	DNP	0.1μF	2.2nF	47μF/6.3V or 2 x 22μF
12V	18V to 70V	23.2kΩ	10kΩ	715Ω	DNP	0.1μF	2.2nF	47μF/16V or 2 x 22μF

Thermal Measurements and Safe Operating Area

Measuring the IC's case temperature is recommended to ensure it is within its operating limits. Although this might seem like a very elementary task, it is easy to get erroneous results. The most common mistake is to use the standard thermal couple that comes with a thermal meter. This thermal couple wire gauge is large, typically 22 gauge, and behaves like a heatsink, resulting in a lower case measurement.

Two methods of temperature measurement are using a smaller thermal couple wire or an infrared thermometer. If a thermal couple wire is used, it must be constructed of 36-gauge wire or higher (smaller wire size) to minimize the wire heat-sinking effect. In addition, the thermal couple tip must be covered in either thermal grease or thermal glue to make sure that the thermal couple junction is making good contact with the case of the IC. Omega brand thermal couple (5SC-TT-K-36-36) is adequate for most applications.

Wherever possible, an infrared thermometer is recommended. The measurement spot size of most infrared thermometers is too large for an accurate reading on a small form factor ICs.

However, an IR thermometer from Optris has a 1mm spot size, which makes it a good choice for measuring the hottest point on the case. An optional stand makes it easy to hold the beam on the IC for long periods of time.

The safe operating area (SOA) of the MIC28304 is shown in the [Typical Characteristics – 275kHz Switching Frequency](#) section. These thermal measurements were taken on MIC28304 evaluation board. Since the MIC28304 is an entire system comprised of switching regulator controller, MOSFETs and inductor, the part needs to be considered as a system. The SOA curves will give guidance to reasonable use of the MIC28304.

Emission Characteristics of MIC28304

The MIC28304 integrates switching components in a single package, so the MIC28304 has reduced emission compared to standard buck regulator with external MOSFETS and inductors. The radiated EMI scans for MIC28304 are shown in the [Typical Characteristics](#) section. The limit on the graph is per EN55022 Class B standard.

PCB Layout Guidelines

Warning: To minimize EMI and output noise, follow these layout recommendations.

PCB layout is critical to achieve reliable, stable and efficient performance. A ground plane is required to control EMI and minimize the inductance in power, signal and return paths.

The following figures optimized from small form factor point of view shows top and bottom layer of a four layer PCB. It is recommended to use mid layer 1 as a continuous ground plane.

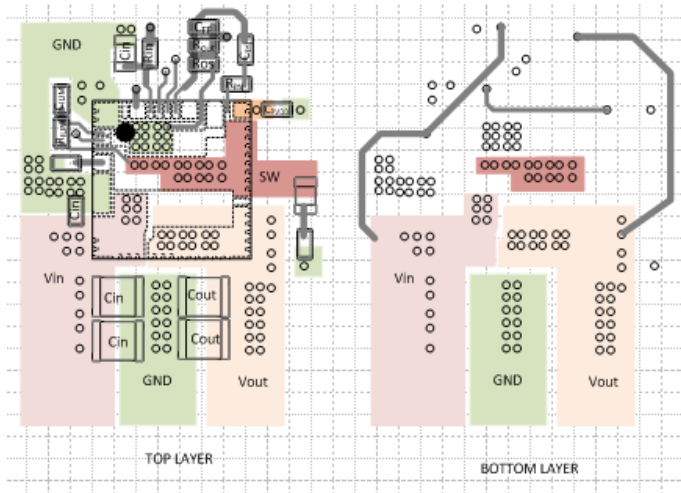

Figure 12. Top And Bottom Layer of a Four-Layer Board

The following guidelines should be followed to insure proper operation of the MIC28304 converter:

IC

- The analog ground pin (GND) must be connected directly to the ground planes. Do not route the GND pin to the PGND pin on the top layer.
- Place the IC close to the point of load (POL).
- Use fat traces to route the input and output power lines.
- Analog and power grounds should be kept separate and connected at only one location.

Input Capacitor

- Place the input capacitors on the same side of the board and as close to the IC as possible.
- Place several vias to the ground plane close to the input capacitor ground terminal.
- Use either X7R or X5R dielectric input capacitors. Do not use Y5V or Z5U type capacitors.
- Do not replace the ceramic input capacitor with any other type of capacitor. Any type of capacitor can be placed in parallel with the input capacitor.
- If a Tantalum input capacitor is placed in parallel with the input capacitor, it must be recommended for switching regulator applications and the operating voltage must be derated by 50%.
- In “Hot-Plug” applications, a Tantalum or Electrolytic bypass capacitor must be used to limit the over-voltage spike seen on the input supply with power is suddenly applied.

RC Snubber

- Place the RC snubber on the same side of the board and as close to the SW pin as possible.

SW Node

- Do not route any digital lines underneath or close to the SW node.
- Keep the switch node (SW) away from the feedback (FB) pin.

Output Capacitor

- Use a wide trace to connect the output capacitor ground terminal to the input capacitor ground terminal.
- Phase margin will change as the output capacitor value and ESR changes. Contact the factory if the output capacitor is different from what is shown in the BOM.
- The feedback trace should be separate from the power trace and connected as close as possible to the output capacitor. Sensing a long high-current load trace can degrade the DC load regulation.

Evaluation Board Schematics

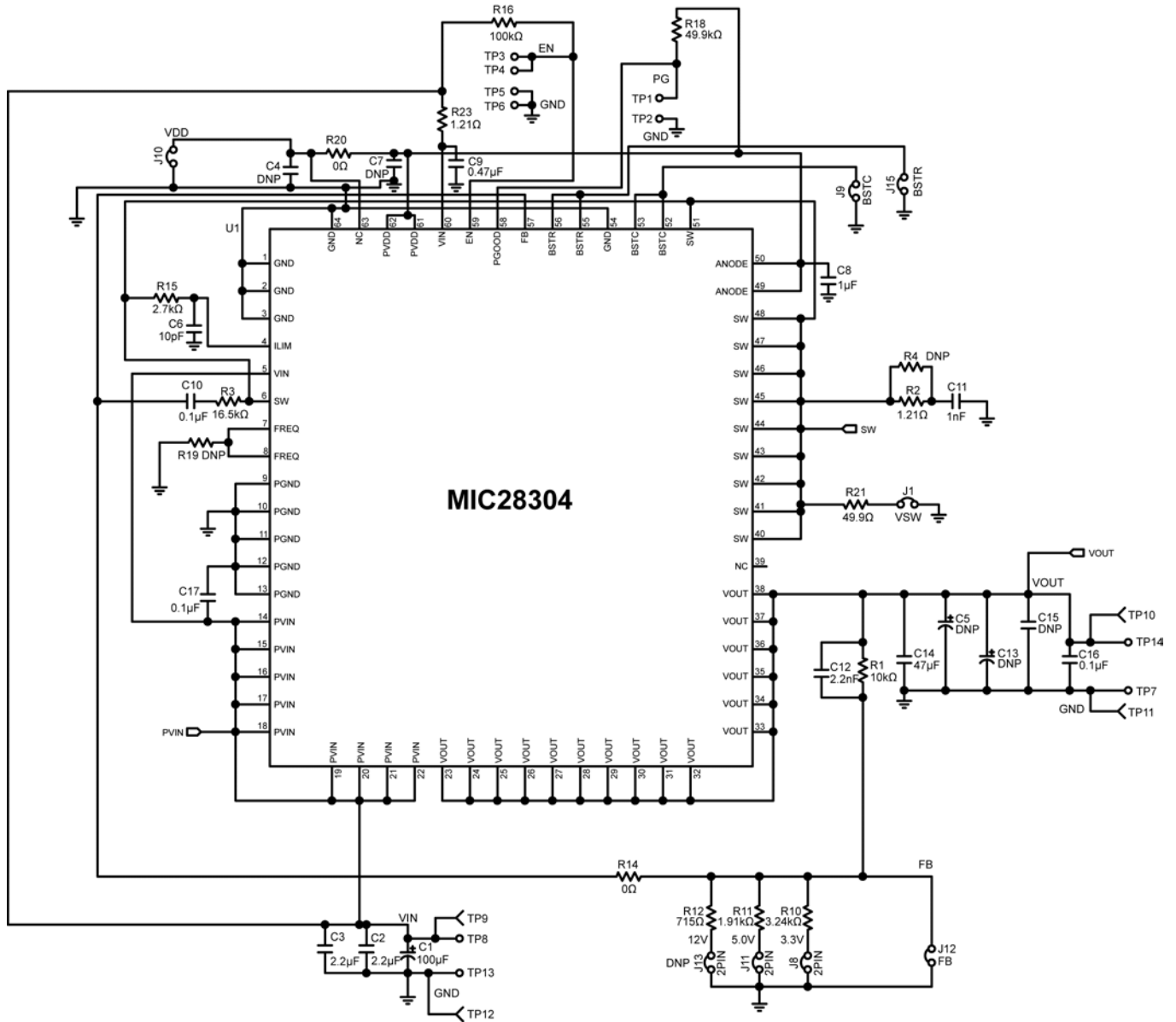

Figure 13. Schematic of MIC28304 Evaluation Board (J1, J8, J10, J11, J12, J13, R14, R20, and R21 are for Testing Purposes)

Evaluation Board Schematics (Continued)

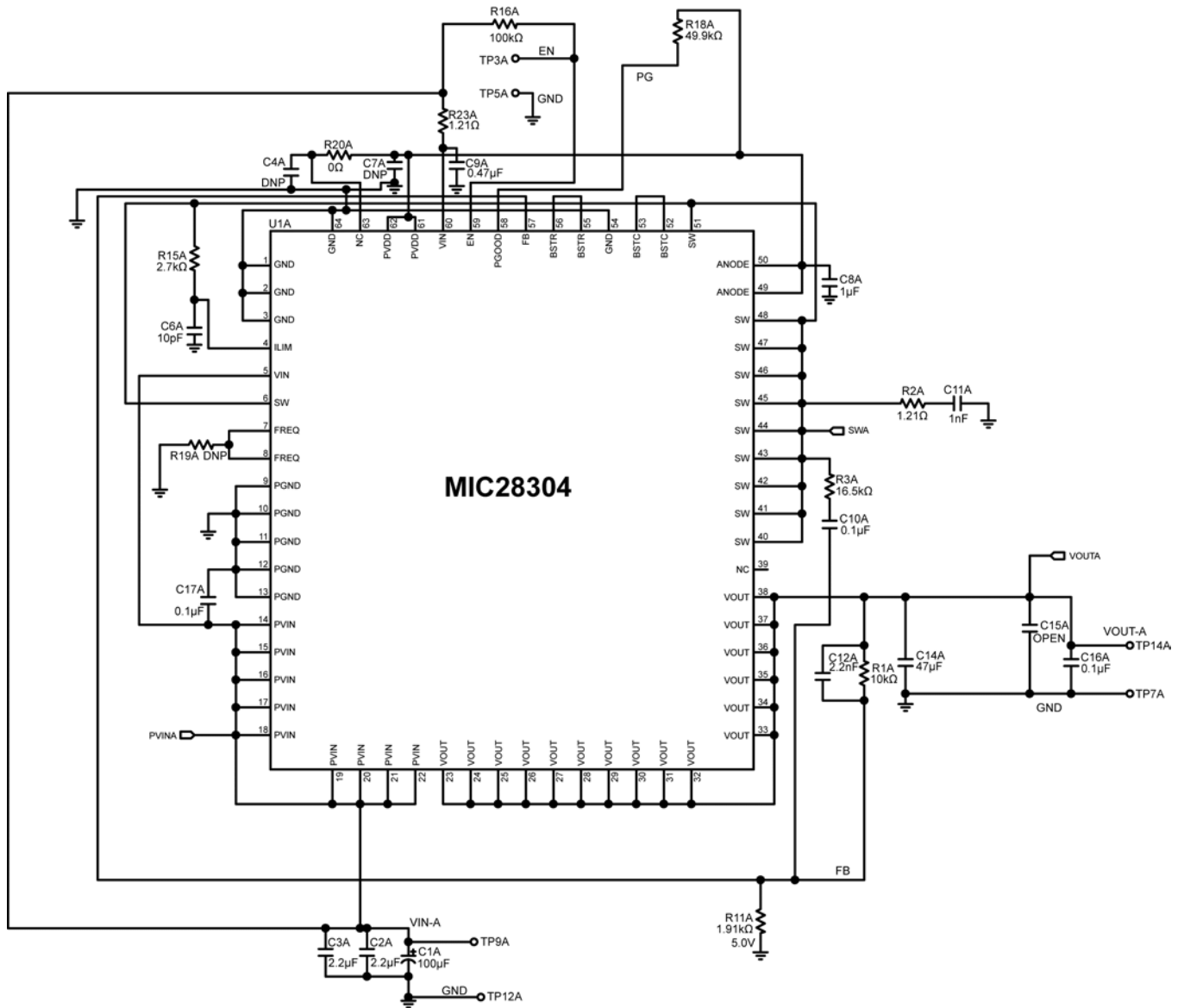

Figure 14. Schematic of MIC28304 Evaluation Board (Optimized for Smallest Footprint)

Bill of Materials

Item	Part Number	Manufacturer	Description	Qty.
C1	EEU-FC2A101	Panasonic ⁽⁶⁾	100µF Aluminum Capacitor, 100V	1
C2, C3	GRM32ER72A225K	Murata ⁽⁷⁾	2.2µF/100V Ceramic Capacitor, X7R, Size 1210	2
	C3225X7R2A225K	TDK ⁽⁸⁾		
	12101C225KAT2A	AVX ⁽⁹⁾		
C6	GCM1885C2A100JA16D	Murata	10pF, 100V, 0603, NPO	1
	06031A100JAT2A	AVX		
C8	GRM188R70J105KA01D	Murata	1µF/6.3V Ceramic Capacitor, X7R, Size 0603	1
	06036C105KAT2A	AVX		
	C1608X5R0J105K	TDK		
C9	GRM21BR72A474KA73	Murata	0.47µF/100V Ceramic Capacitor, X7R, Size 0805	1
	08051C474KAT2A	AVX		
C10, C17	GRM188R72A104KA35D	Murata	0.1µF/100V Ceramic Capacitor, X7R, Size 0603	2
	C1608X7S2A104K	TDK	0.1µF/100V, X7S, 0603	
C11	GRM188R72A102KA01D	Murata	1nF/100V Ceramic Capacitor, X7R, Size 0603	1
	06031C102KAT2A	AVX		
	C1608X7R2A102K	TDK		
C12	GRM188R72A222KA01D	Murata	2.2nF/100V Ceramic Capacitor, X7R, Size 0603	1
	06031C222KAT2A	AVX		
	C1608X7R2A222K	TDK		
C14	GRM31CR60J476ME19K	Murata	47µF/6.3V Ceramic Capacitor, X5R, Size 1210	1
	12106D476MAT2A	AVX		
C16	GRM188R71H104KA93D	Murata	0.1µF/6.3V Ceramic Capacitor, X7R, Size 0603	1
	06035C104KAT2A	AVX		
	C1608X7R1H104K	TDK		
C4, C5, C7, C13, C15				DNP

Notes:

6. Panasonic: www.panasonic.com.
7. Murata: www.murata.com.
8. TDK: www.tdk.com.
9. AVX: www.avx.com.

Bill of Materials (Continued)

Item	Part Number	Manufacturer	Description	Qty.
R1	CRCW060310K0FKEA	Vishay Dale ⁽¹⁰⁾	10kΩ Resistor, Size 0603, 1%	1
R2	CRCW08051R21FKEA	Vishay Dale	1.21Ω Resistor, Size 0805, 5%	1
R3	CRCW06031652F	Vishay Dale	16.5kΩ Resistor, Size 0603, 1%	1
R10	CRCW06033K24FKEA	Vishay Dale	3.24kΩ Resistor, Size 0603, 1%	1
R11	CRCW06031K91FKEA	Vishay Dale	1.91kΩ Resistor, Size 0603, 1%	1
R12	CRCW0603715R0FKEA	Vishay Dale	715Ω Resistor, Size 0603, 1%	DNP
R14, R20	CRCW06030000FKEA	Vishay Dale	0Ω Resistor, Size 0603, 5%	2
R15	CRCW04022K70JNED	Vishay Dale	2.7kΩ Resistor, Size 0603, 1%	1
R16	CRCW0603100KFKEAHP	Vishay Dale	100kΩ Resistor, Size 0603, 1%	1
R18	CRCW060349K9FKEA	Vishay Dale	49.9kΩ Resistor, Size 0603, 1%	1
R21	CRCW060349R9FKEA	Vishay Dale	49.9Ω Resistor, Size 0603, 1%	1
R23	CRCW06031R21FKEA	Vishay Dale	1.21Ω Resistor, Size 0603, 1%	1
R4, R19				DNP
All reference designators ending with "A"	Open			
U1	MIC28304-1YMP	Micrel, Inc. ⁽¹¹⁾	70V, 3A Power Module – Hyper Speed Control Family	1
	MIC28304-2YMP			

Notes:10. Vishay: www.vishay.com.11. Micrel, Inc.: www.micrel.com.

PCB Layout Recommendations

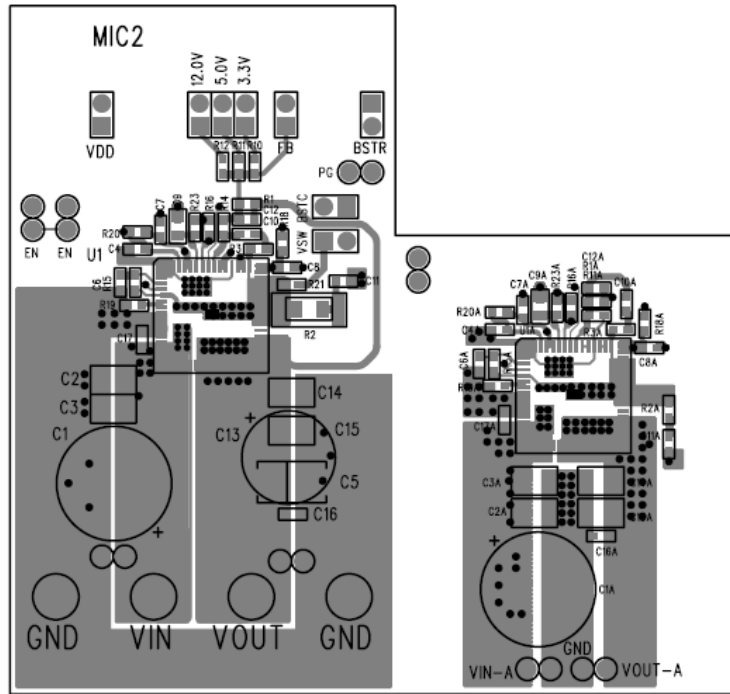

Evaluation Board Top Layer

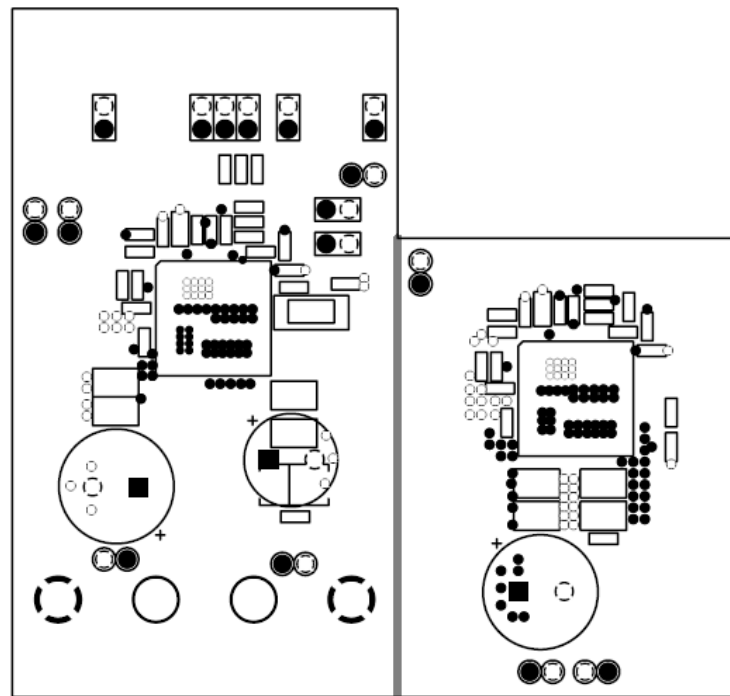

Evaluation Board Mid-Layer 1 (Ground Plane)

PCB Layout Recommendations (Continued)

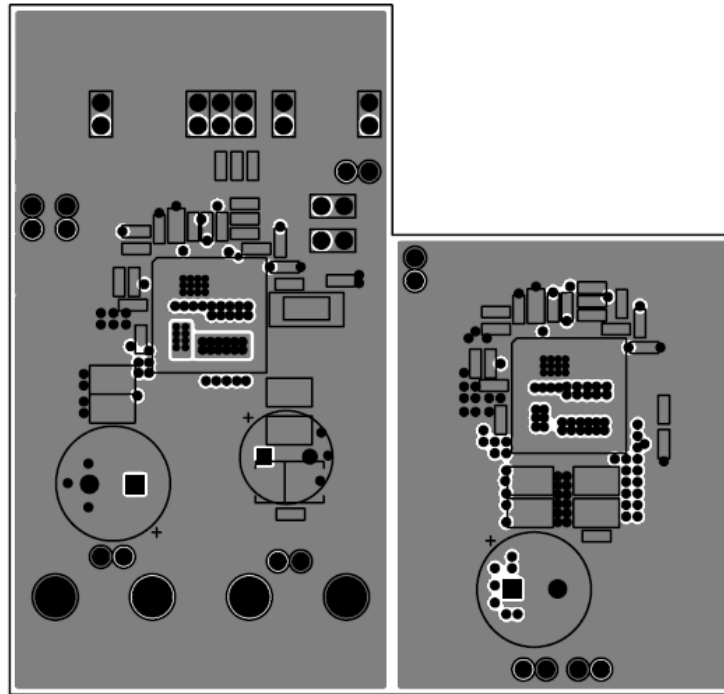

Evaluation Board Mid-Layer 2

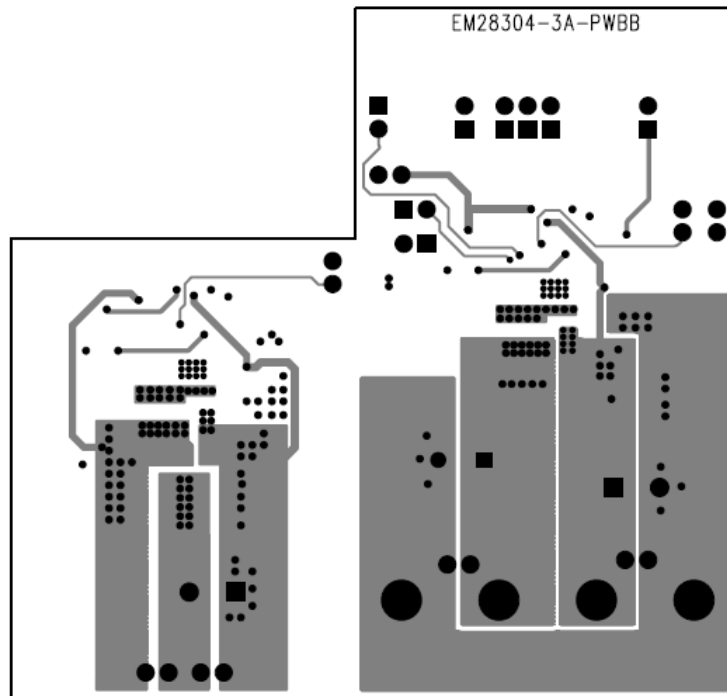

Evaluation Board Bottom Layer

Package Information⁽¹²⁾

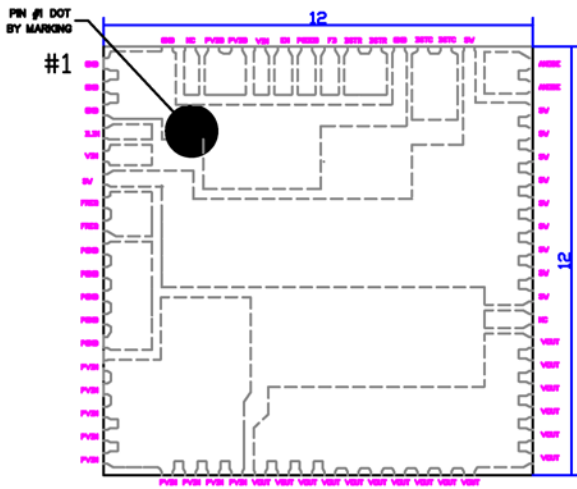

Top View
NOTE: 1, 2, 3

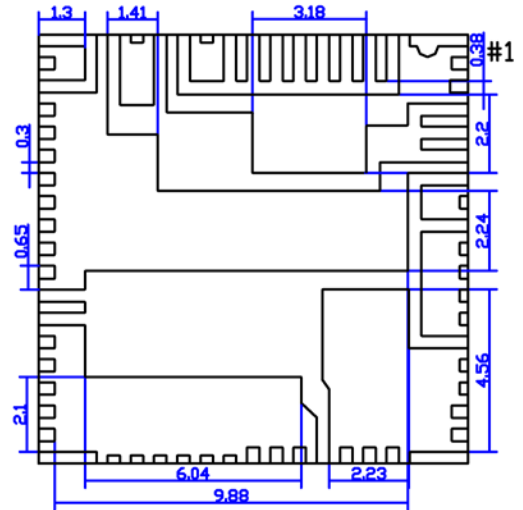

Bottom View
NOTE: 1, 2, 3

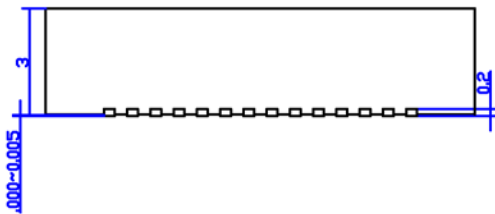

Top View
NOTE: 1, 2, 3

64-Pin 12mm x 12mm QFN (MP)

Note:

12. Package information is correct as of the publication date. For updates and most current information, go to www.micrel.com.

Recommended Land Pattern

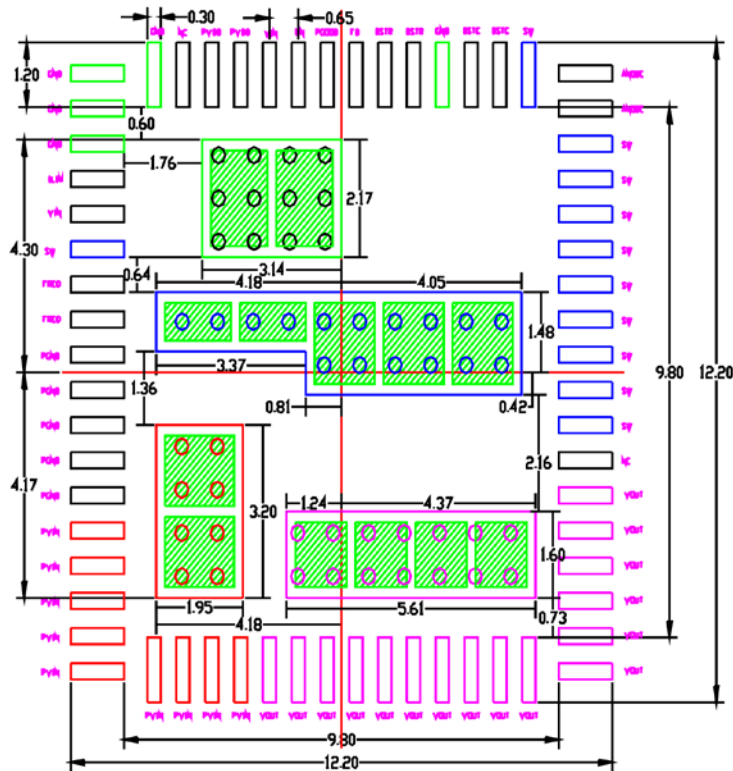

Recommended Land Pattern

NOTE: 4, 5, 6 7

- NOTE:
1. MAX PACKAGE WARPAGE IS 0.05 MM
 2. MAX ALLOWABLE BURR IS 0.076MM IN ALL DIRECTIONS
 3. PIN #1 IS ON TOP WILL BE LASER MARKED
 4. BLACK CIRCLES IN LAND PATTERN REPRESENT THERMAL VIA & SHOULD BE CONNECTED TO GND FOR MAXIMUM PERFORMANCE.
 5. GREEN RECTANGLES (SHADED AREA) REPRESENT SOLDER STENCIL OPENING ON EXPOSED PAD AREA.
 6. RED COLORED PADS, BLUE COLORED PADS & PURPLE COLORED PADS REPRESENT DIFFERENT POTENTIALS. DO NOT CONNECT TO GND.
 7. RECOMMENDED SOLDER STENCIL OPENING AND VIA SIZES :

MICREL, INC. 2180 FORTUNE DRIVE SAN JOSE, CA 95131 USA
 TEL +1 (408) 944-0800 FAX +1 (408) 474-1000 WEB <http://www.micrel.com>

Micrel makes no representations or warranties with respect to the accuracy or completeness of the information furnished in this data sheet. This information is not intended as a warranty and Micrel does not assume responsibility for its use. Micrel reserves the right to change circuitry, specifications and descriptions at any time without notice. No license, whether express, implied, arising by estoppel or otherwise, to any intellectual property rights is granted by this document. Except as provided in Micrel's terms and conditions of sale for such products, Micrel assumes no liability whatsoever, and Micrel disclaims any express or implied warranty relating to the sale and/or use of Micrel products including liability or warranties relating to fitness for a particular purpose, merchantability, or infringement of any patent, copyright or other intellectual property right.

Micrel Products are not designed or authorized for use as components in life support appliances, devices or systems where malfunction of a product can reasonably be expected to result in personal injury. Life support devices or systems are devices or systems that (a) are intended for surgical implant into the body or (b) support or sustain life, and whose failure to perform can be reasonably expected to result in a significant injury to the user. A Purchaser's use or sale of Micrel Products for use in life support appliances, devices or systems is a Purchaser's own risk and Purchaser agrees to fully indemnify Micrel for any damages resulting from such use or sale.

© 2014 Micrel, Incorporated.